

protective equipment against falls from height



PROTEKT®



EUROPEAN UNION
EUROPEAN REGIONAL
DEVELOPMENT FUND



Safety harness

We manufacture harnesses according your own project.

Available colours of the harness webbings



polyamide, 44 mm, others colours on request

Harness buckles

<p>1</p> <p>stainless steel</p> <p>Automatic connecting and regulating buckle for shoulder, leg and belt straps</p>	<p>2</p> <p>aluminum</p> <p>Automatic connecting and regulating buckle for shoulder, leg and belt straps</p>	<p>3</p> <p>stainless steel zinc plated steel</p> <p>Connecting and regulating buckle for shoulder, leg and belt straps</p>	
<p>4</p> <p>stainless steel zinc plated steel black painted steel</p> <p>Connecting and regulating buckle for shoulder, leg and belt straps</p>	<p>5</p> <p>zinc plated steel</p> <p>Connecting and regulating buckle for belt straps</p>	<p>6</p> <p>stainless steel zinc plated steel</p> <p>Connecting and regulating buckle for shoulder and leg straps</p>	<p>7</p> <p>zinc plated steel</p> <p>Connecting and regulating buckle for shoulder and leg straps</p>
<p>8</p> <p>zinc plated steel</p> <p>Regulating buckle for shoulder and leg straps</p>	<p>9</p> <p>stainless steel zinc plated steel</p> <p>Regulating buckle for shoulder and leg straps</p>	<p>10</p> <p>zinc plated steel</p> <p>Regulating buckle for shoulder and leg straps</p>	<p>11</p> <p>zinc plated steel black painted steel</p> <p>Regulating buckle for shoulder and leg straps</p>
<p>12</p> <p>aluminum stainless steel zinc plated steel black painted steel</p> <p>Forged anchorage buckle for harness and belt</p>	<p>13</p> <p>zinc plated steel</p> <p>Forged anchorage buckle for harness and belt</p>	<p>14</p> <p>zinc plated steel black painted steel</p> <p>Forged anchorage buckle for harness and belt</p>	<p>15</p> <p>zinc plated steel</p> <p>Forged buckle for belt</p>

Safety harness

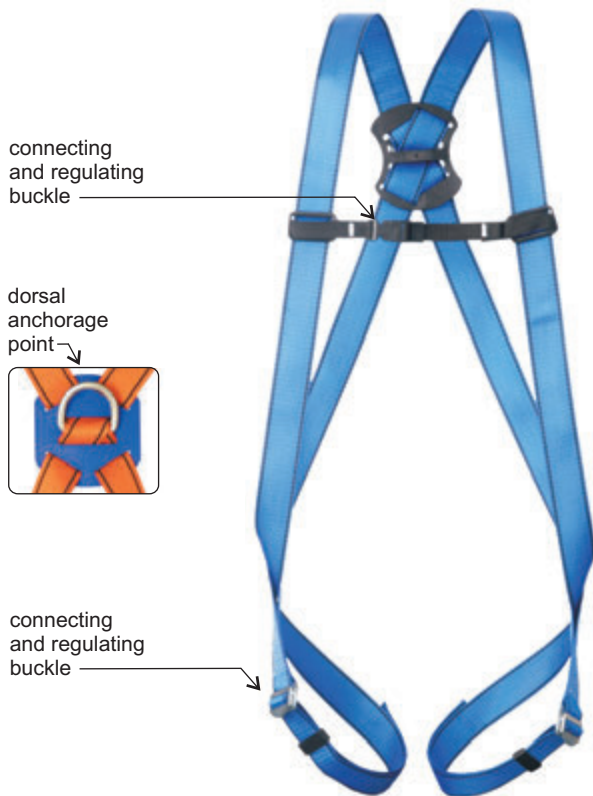

P-01 SAFETY HARNESS

EN 361



Ref.: AB 101 01

Harness with dorsal anchorage point.

Size: M-XL - 650g

XXL - 660g

One regulation for legs and shoulders straps.



P-02 SAFETY HARNESS

EN 361 EN 358



Ref.: AB 102 01

Harness with dorsal anchorage point and work positioning belt.

Size: M-XL - 1080g

XXL - 1180g

One regulation for legs and shoulders straps.



Safety harness

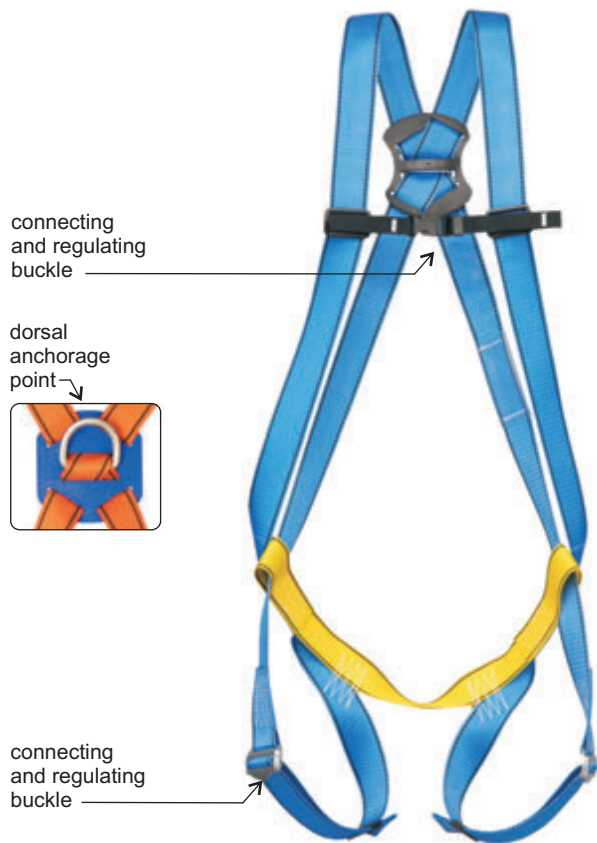

P-01S SAFETY HARNESS

EN 361



Ref.: AB 101 02

Harness with dorsal anchorage point.

Size: M-XL - 670g

XXL - 680g

One regulation for legs and shoulders straps.



P-02S SAFETY HARNESS

EN 361 EN 358



Ref.: AB 102 02

Harness with dorsal anchorage point and work positioning belt.

Size: M-XL - 1100g

XXL - 1200g

One regulation for legs and shoulders straps.

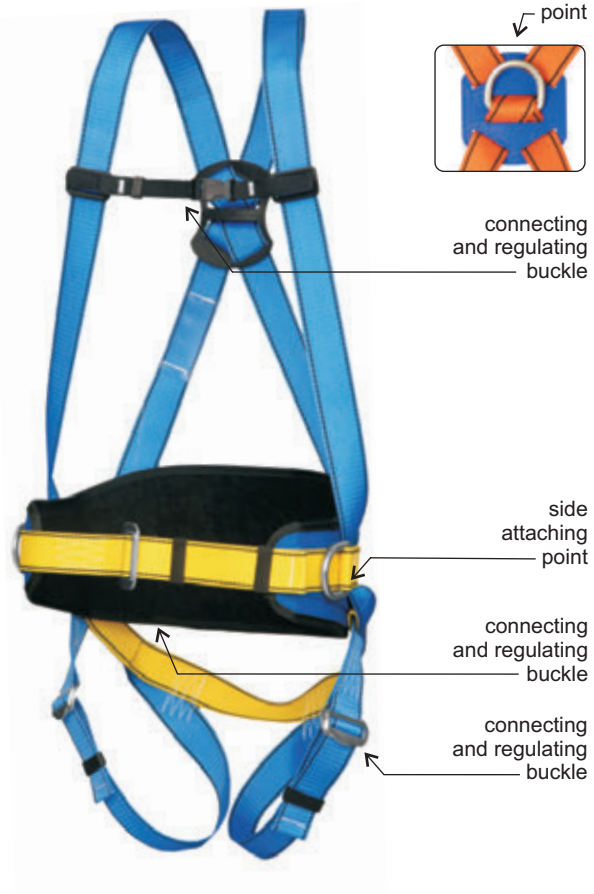

Safety harness

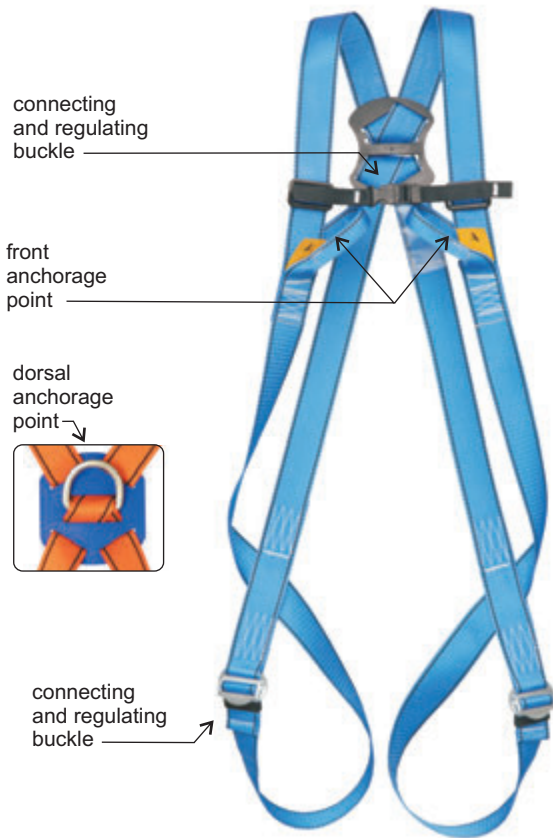

P-03 SAFETY HARNESS

EN 361



Ref.: AB 103 01

Harness with front and dorsal anchorage point..

Size: M-XL - 690g

XXL - 700g

One regulation for legs and shoulders straps.



dorsal anchorage point

P-05 SAFETY HARNESS

EN 361 EN 358



Ref.: AB 105 01

Harness with front, dorsal anchorage point and work positioning belt.

Size: M-XL - 1120g

XXL - 1220g

One regulation for legs and shoulders straps.

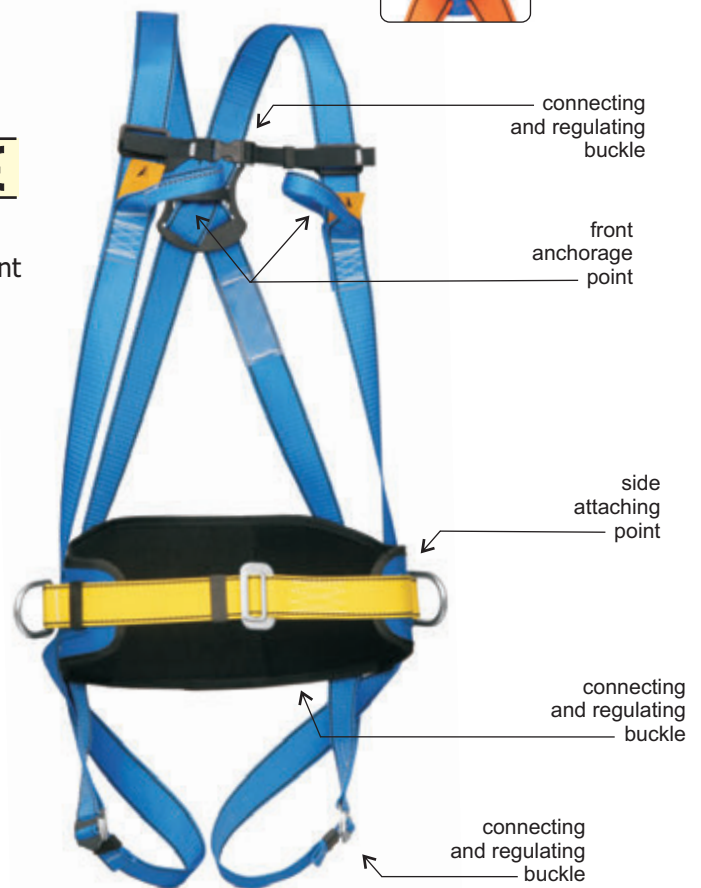

Safety harness

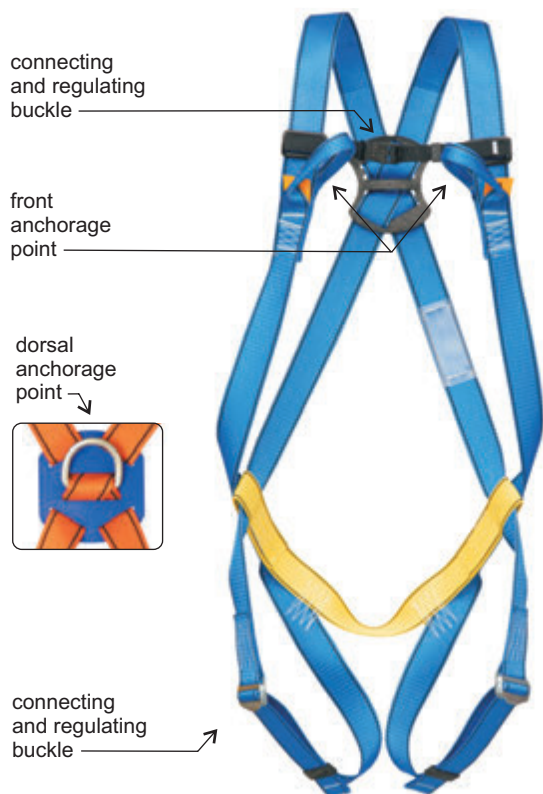

P-03S SAFETY HARNESS

EN 361



Ref.: AB 103 02

Harness with front and dorsal anchorage point..

Size: M-XL - 730g

XXL - 740g

One regulation for legs and shoulders straps.



P-05S SAFETY HARNESS

EN 361 EN 358



Ref.: AB 105 02

Harness with front, dorsal anchorage point and work positioning belt.

Size: M-XL - 1160g

XXL - 1260g

One regulation for legs and shoulders straps.

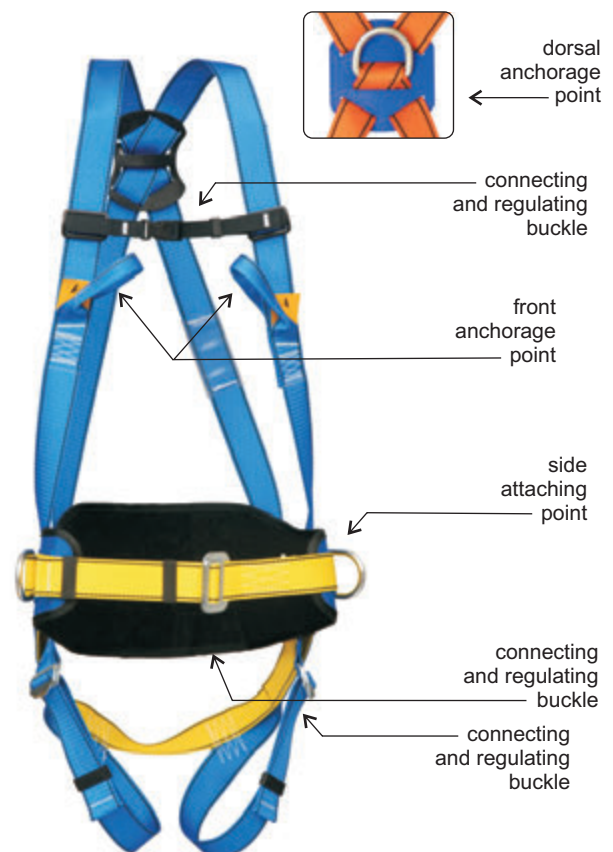

Safety harness

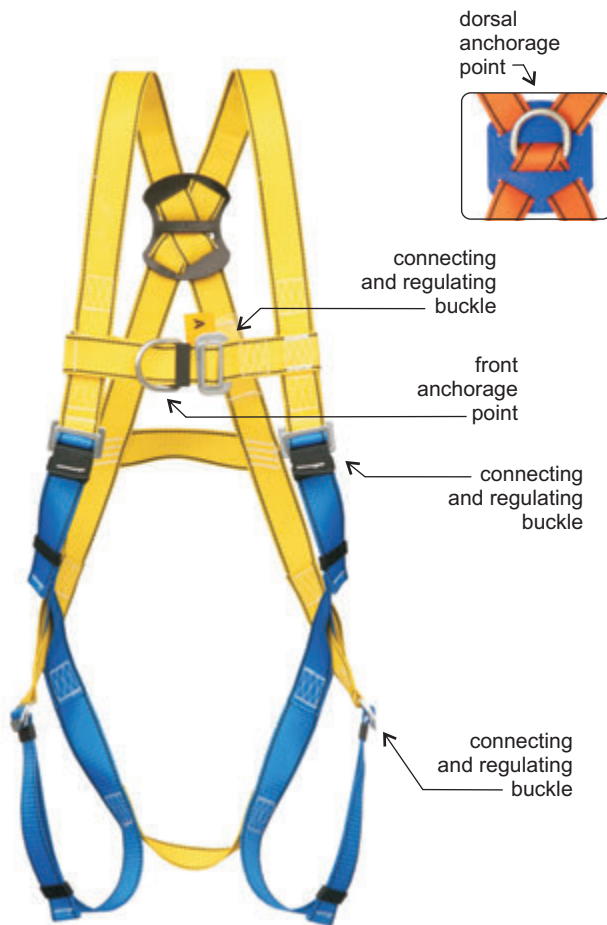

P-11 SAFETY HARNESS **NEW!**

EN 361



Ref.: AB 110 07

Harness with front and dorsal anchorage point.

Size: M-XL - 1100g
XXL - 1150g

Separate regulation for legs and shoulders straps.

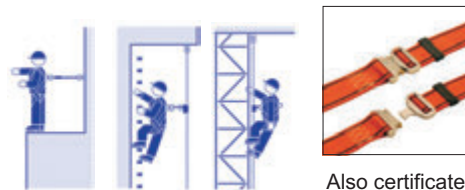

Also certificate with automatic alu buckles

P-11C SAFETY HARNESS **NEW!**

EN 361



Ref.: AB 110 06

Harness with front and dorsal anchorage point.

Size: M-XL - 1150g
XXL - 1200g

Separate regulation for legs and shoulders straps.

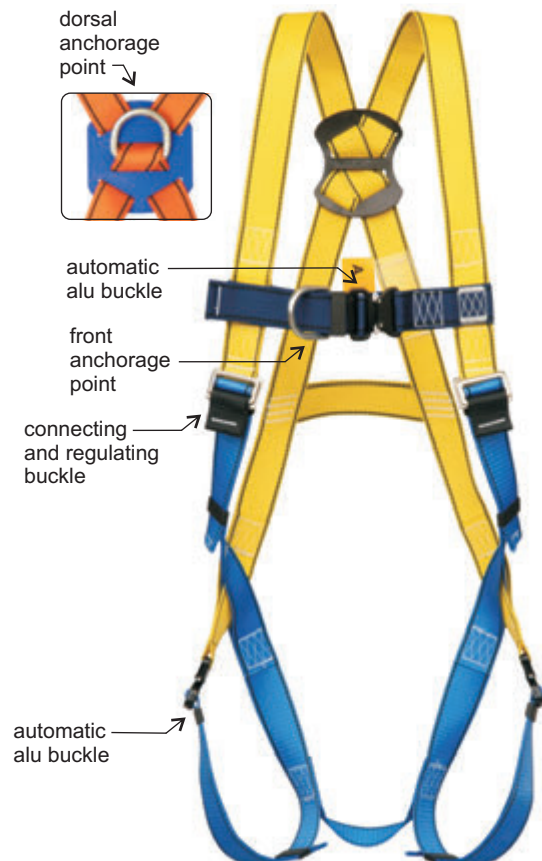

Safety harness

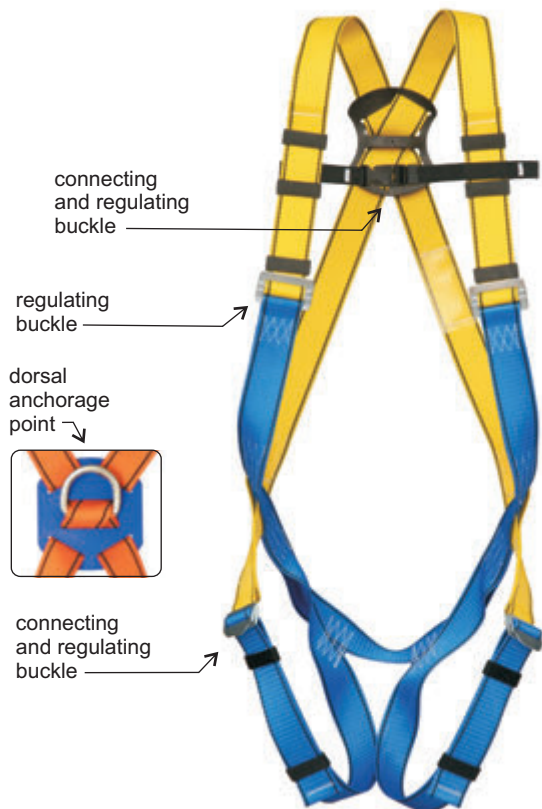

P-10 SAFETY HARNESS

EN 361



Ref.: AB 110 01

Harness with dorsal anchorage point.

Size: M-XL - 870g

XXL - 900g

Separate regulation for legs and shoulders straps.



Also certificate with automatic alu buckles

P-20 SAFETY HARNESS

EN 361 EN 358



Ref.: AB 120 01

Harness with dorsal anchorage point and work positioning belt.

Size: M-XL - 1350g

XXL - 1450g

Separate regulation for legs and shoulders straps.



Also certificate with automatic alu buckles

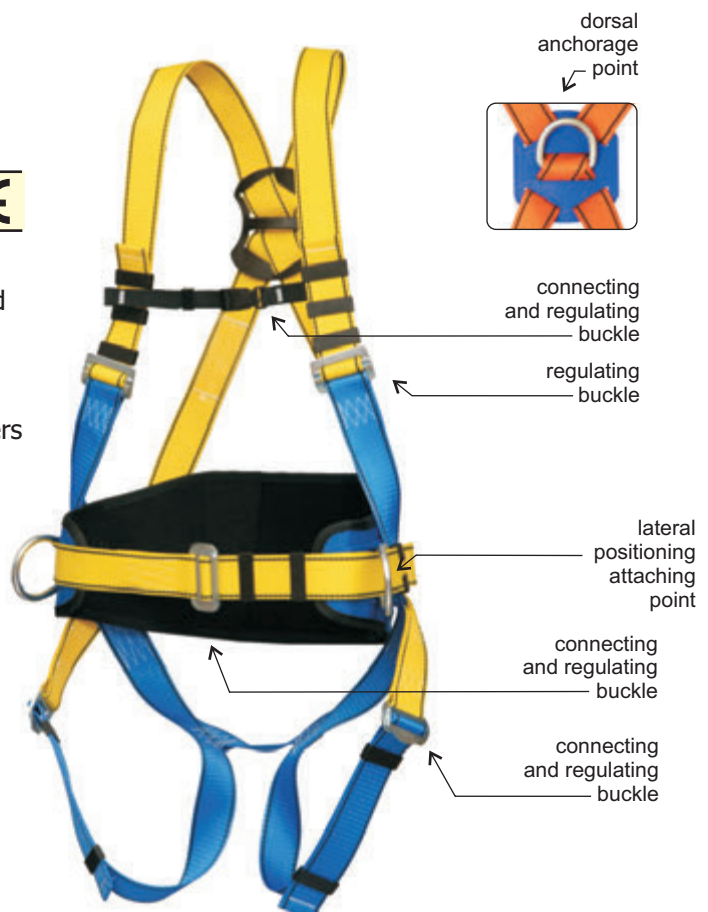

Safety harness

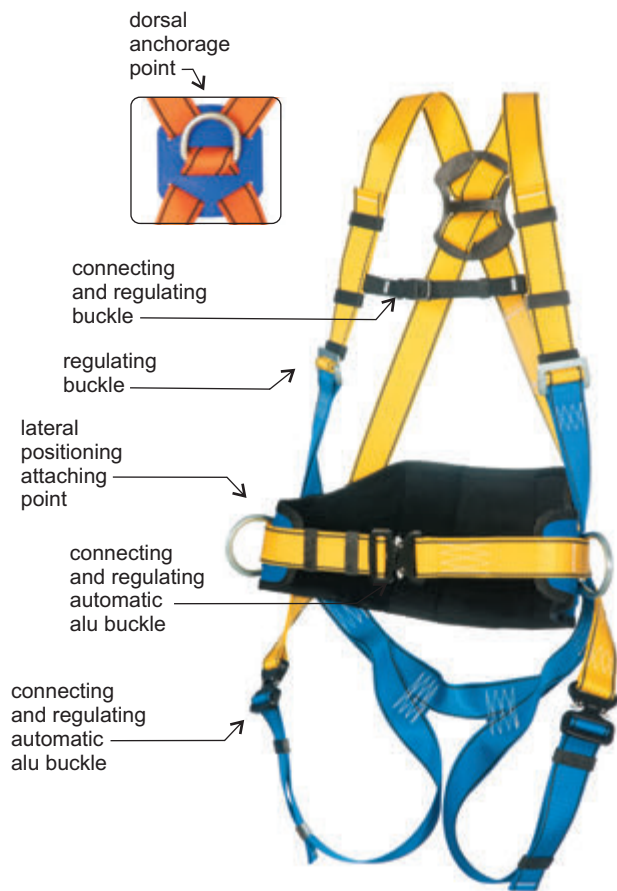

P-20C SAFETY HARNESS

EN 361



Ref.: AB 120 03

Harness with dorsal anchorage point and work positioning belt.

Size: M-XL - 1400g

XXL - 1500g

Separate regulation for legs and shoulders



P-30C SAFETY HARNESS

EN 361 EN 358



Ref.: AB 130 03

Harness with front and dorsal anchorage point.

Size: M-XL - 1100g

XXL - 1180g

Separate regulation for legs and shoulders straps.

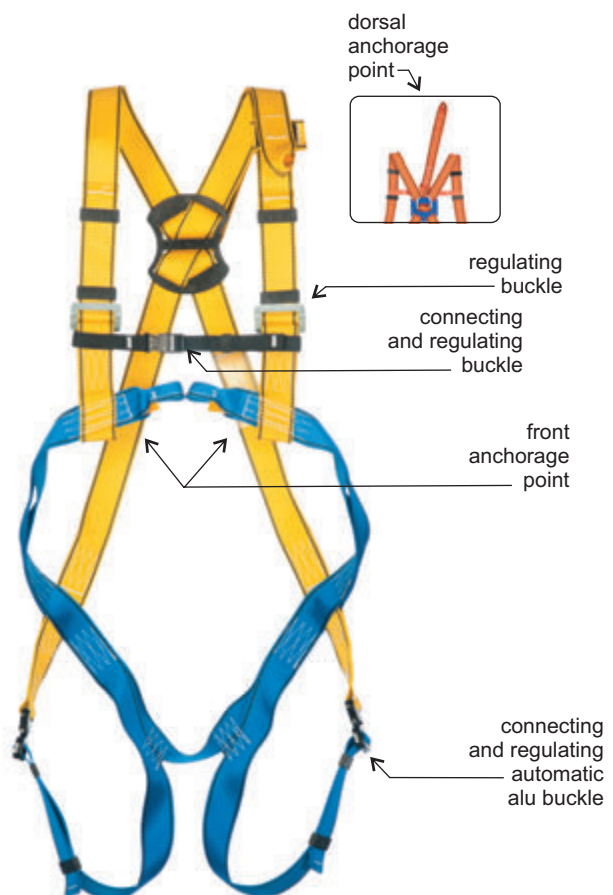

Safety harness

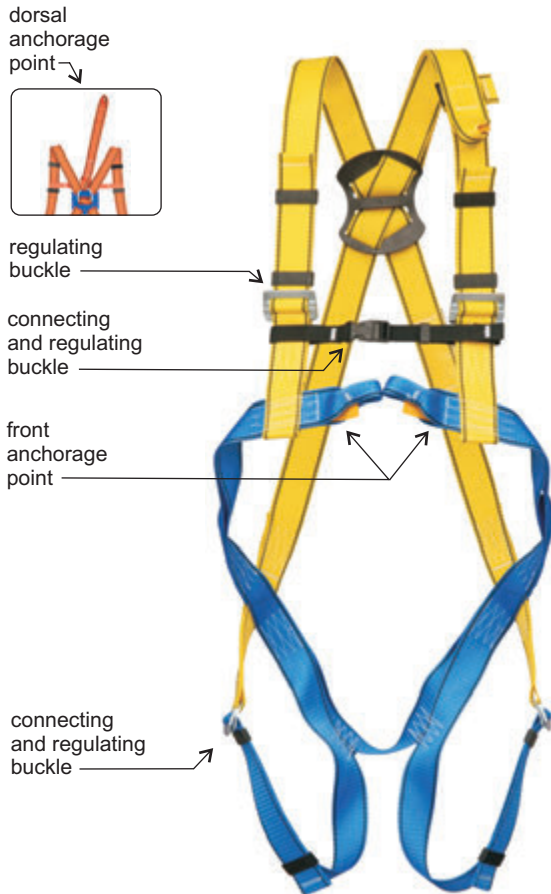

P-30 SAFETY HARNESS

EN 361



Ref.: AB 130 01

Harness with front and dorsal anchorage point.

Size: M-XL - 1000g
XXL - 1060g

Separate regulation for legs and shoulders straps.



Also certificate with automatic alu buckles

P-50 SAFETY HARNESS

EN 361 EN 358



Ref.: AB 150 01

Harness with front and dorsal anchorage point.

Work positioning belt.

Size: M-XL - 1460g
XXL - 1600g

Separate regulation for legs and shoulders straps.



Also certificate with automatic alu buckles

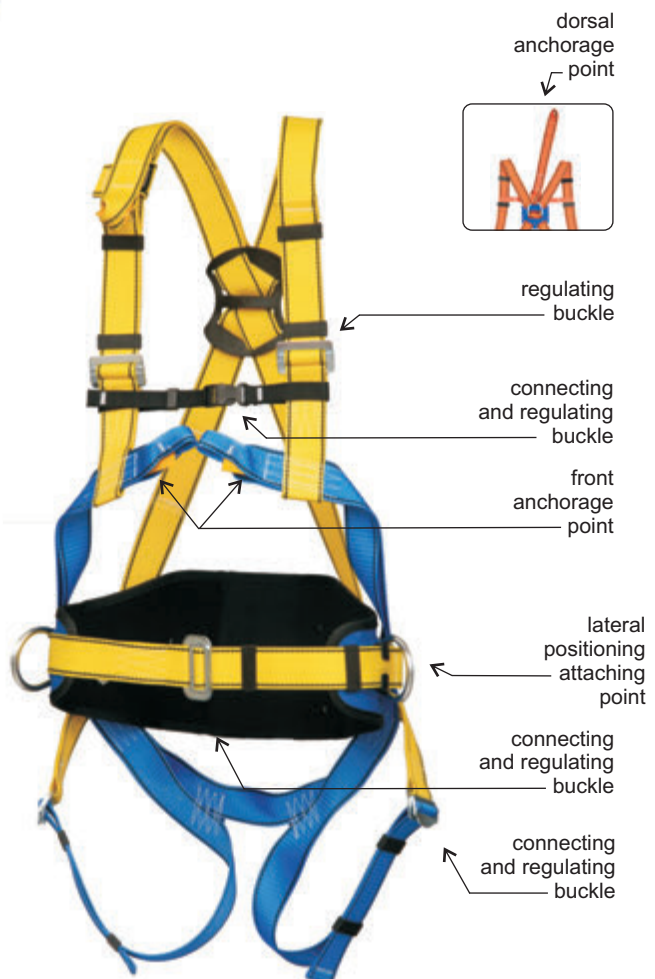

Safety harness

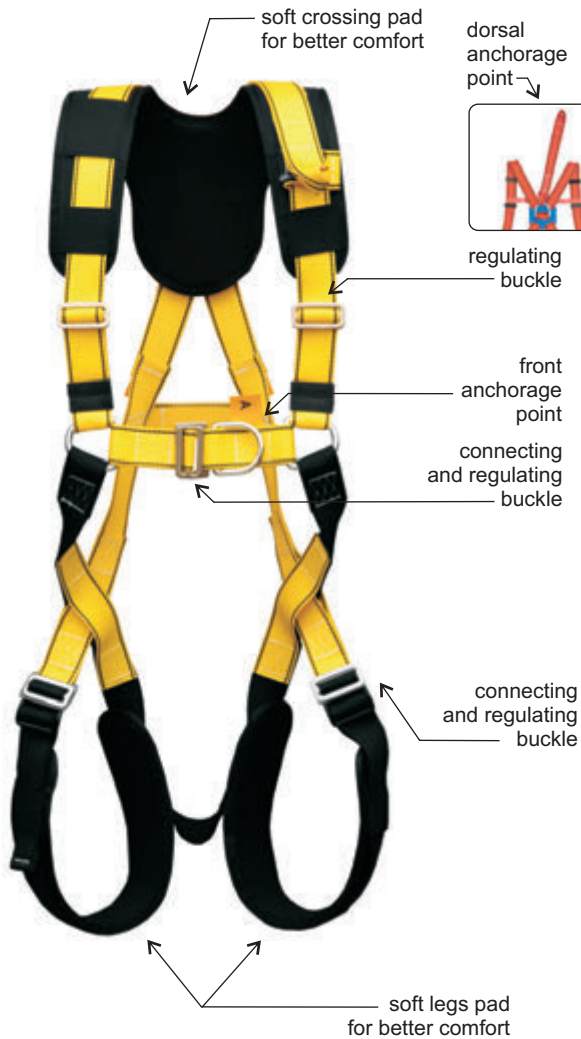

P-33EL SAFETY HARNESS **NEW!**

EN 361



Ref.: AB 133 01

Harness with front and dorsal anchorage point.

Size: M-XL - 1500g
XXL - 1660g

Separate regulation for legs and shoulders straps.



P-34EL SAFETY HARNESS **NEW!**

EN 361



Ref.: AB 134 01

Harness with front and dorsal anchorage point.

Size: M-XL - 1600g
XXL - 1700g

Separate regulation for legs and shoulders straps.

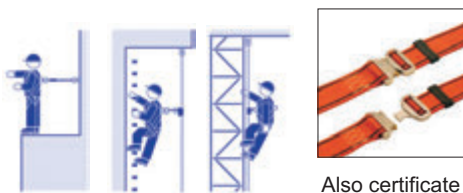

Also certificate with automatic alu buckles

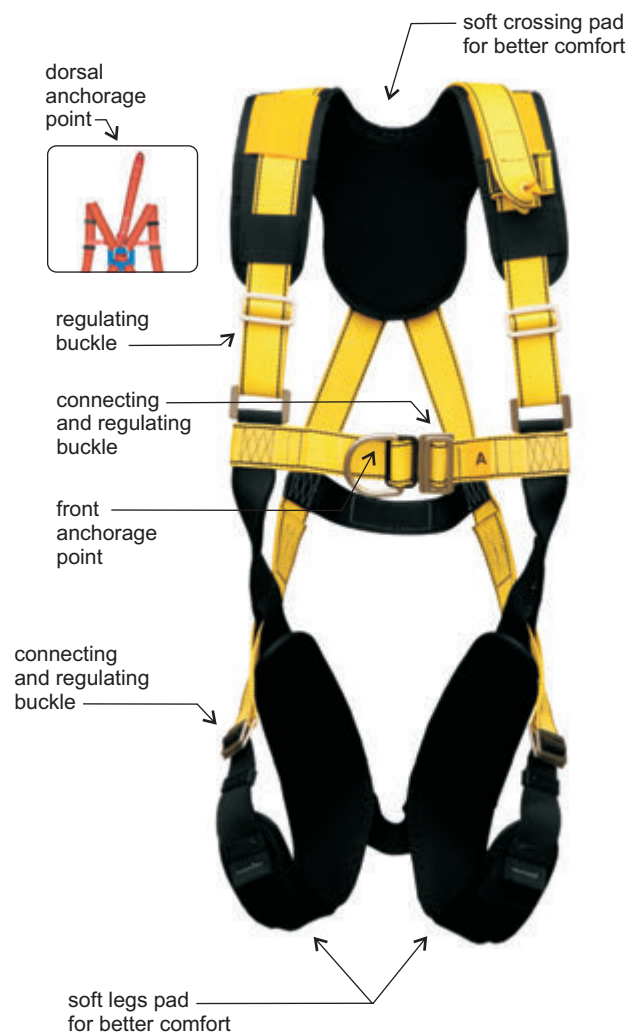

Safety harness

P-36 SAFETY HARNESS

EN 361



Ref.: AB 136 01

Harness with front and dorsal anchorage point.

Size: M-XL - 1000g
XXL - 1060g

Separate regulation for legs and shoulders straps.

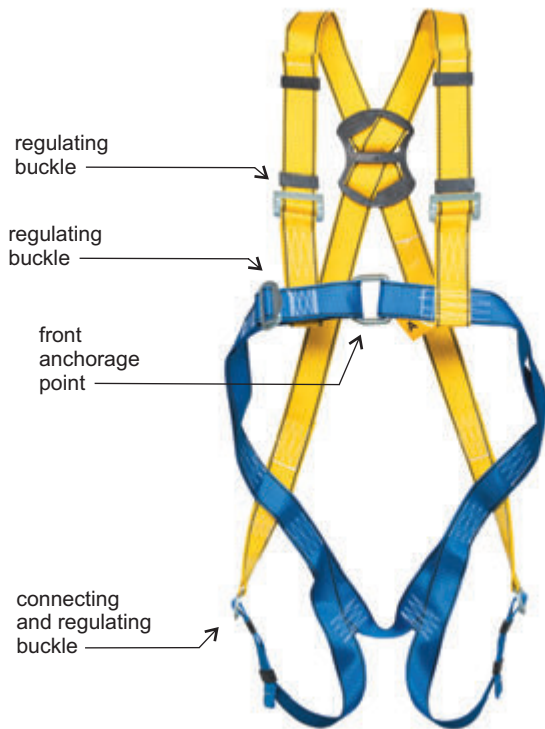

Also certificate with automatic alu buckles

P-56 SAFETY HARNESS

EN 361 EN 358



Ref.: AB 156 01

Harness with front and dorsal anchorage point.

Work positioning belt.

Size: M-XL - 1500g
XXL - 1640g

Separate regulation for legs and shoulders straps.



Also certificate with automatic alu buckles



Safety harness

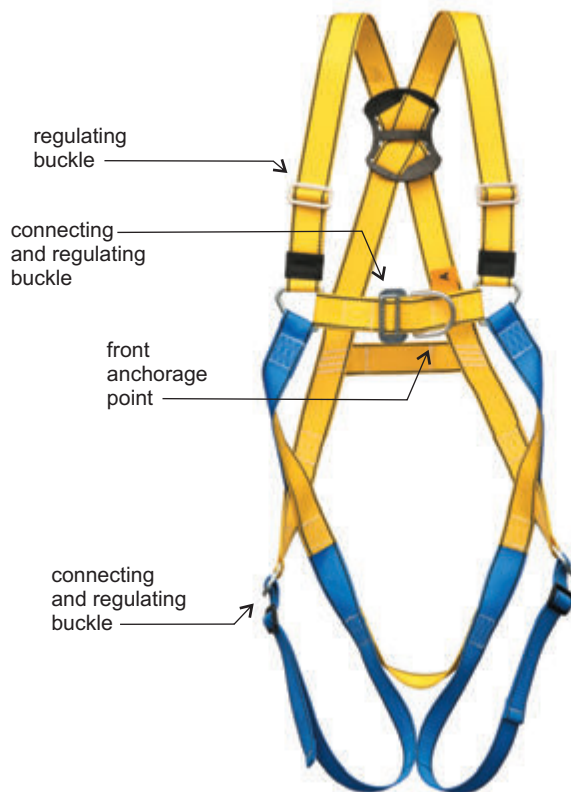

P-35 SAFETY HARNESS

EN 361



Ref.: AB 135 01

Harness with front and dorsal anchorage point.

Size: M-XL - 1150g
XXL - 1200g

Separate regulation for legs and shoulders straps.



P-35E SAFETY HARNESS **NEW!**

EN 361



ELASTIC WEBBING

Ref.: AB 135 02

Harness with front and dorsal anchorage point.

Work positioning belt.

Size: M-XL - 1220g
XXL - 1270g

Separate regulation for legs and shoulders straps.

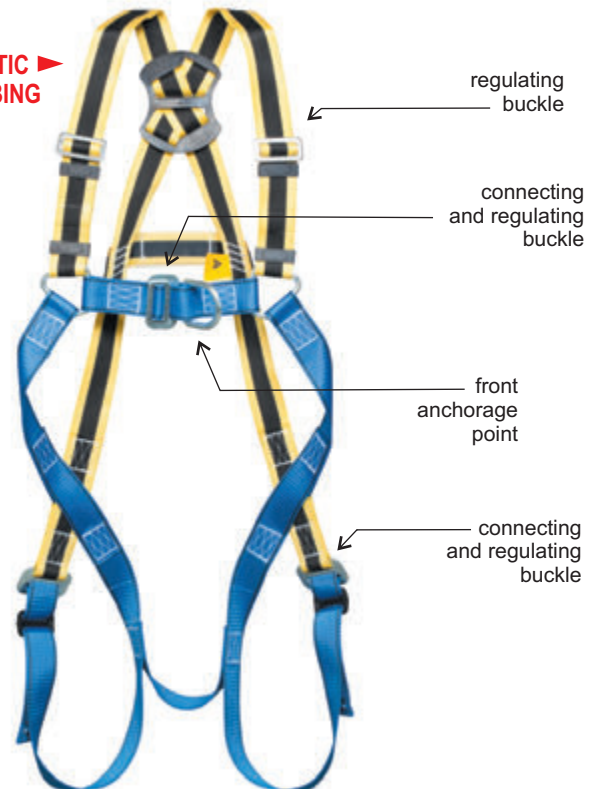

Safety harness

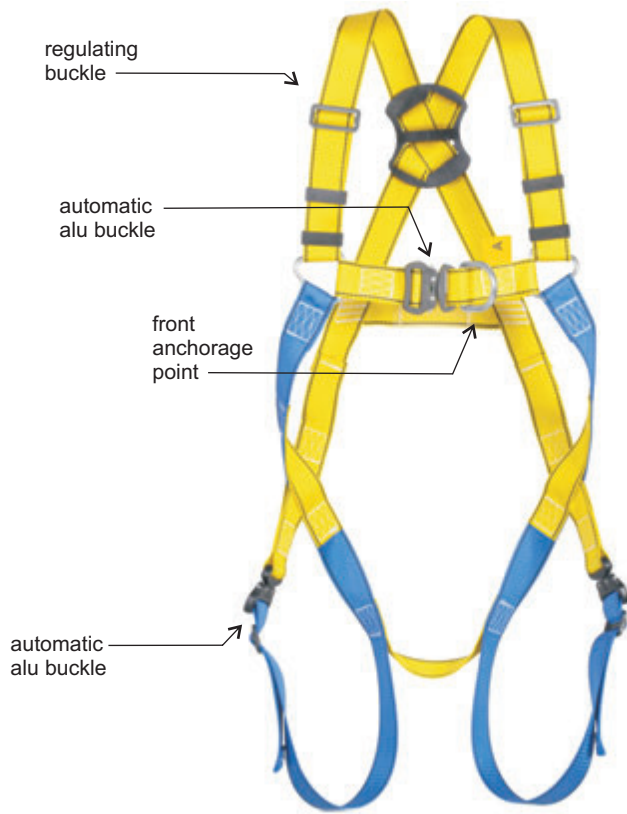

P-35C SAFETY HARNESS **NEW!**

EN 361



Ref.: AB 135 03

Harness with front and dorsal anchorage point.

Size: M-XL - 1200g
XXL - 1250g

Separate regulation for legs and shoulders straps.



P-36C SAFETY HARNESS **NEW!**

EN 361



Ref.: AB 136 03

Harness with front and dorsal anchorage point.

Work positioning belt.

Size: M-XL - 1100g
XXL - 1160g

Separate regulation for legs and shoulders straps.

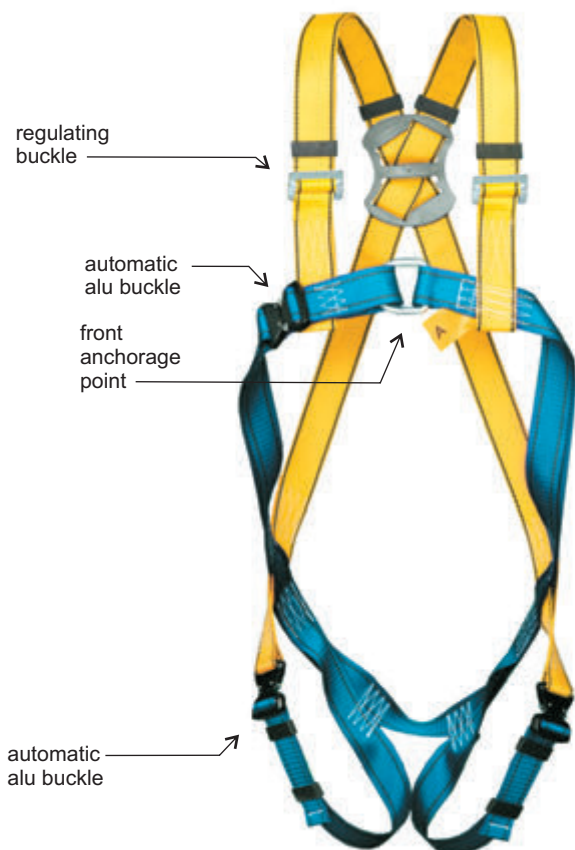

Safety harness

dorsal anchorage point



regulating buckle
connecting and regulating buckle

front anchorage point

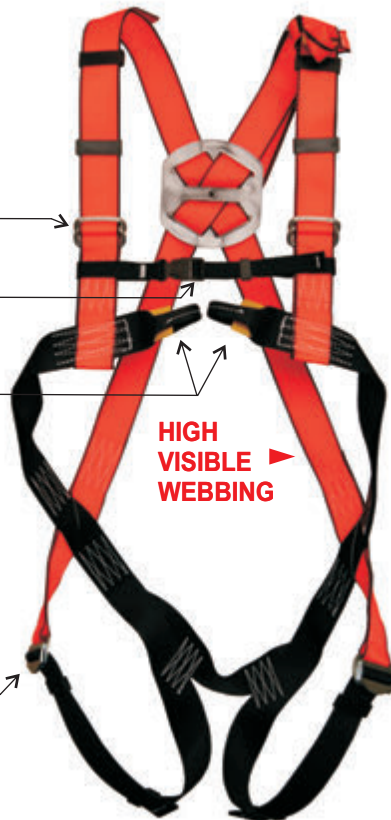

HIGH VISIBLE WEBBING

connecting and regulating buckle

P-30HV SAFETY HARNESS

EN 361



Ref.: AB 130 03

Harness with front and dorsal anchorage point.

Size: M-XL - 1000g
XXL - 1060g

Separate regulation for legs and shoulders straps.



P-10R SAFETY HARNESS

EN 361 EN 1497



Ref.: AB 110 03

Harness with front and dorsal anchorage point.

Rescue anchorage point

Size: M-XL - 1460g
XXL - 1600g

Separate regulation for legs and shoulders straps.

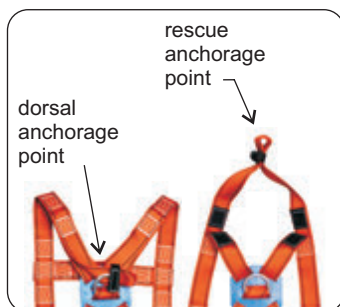

dorsal anchorage point

rescue anchorage point

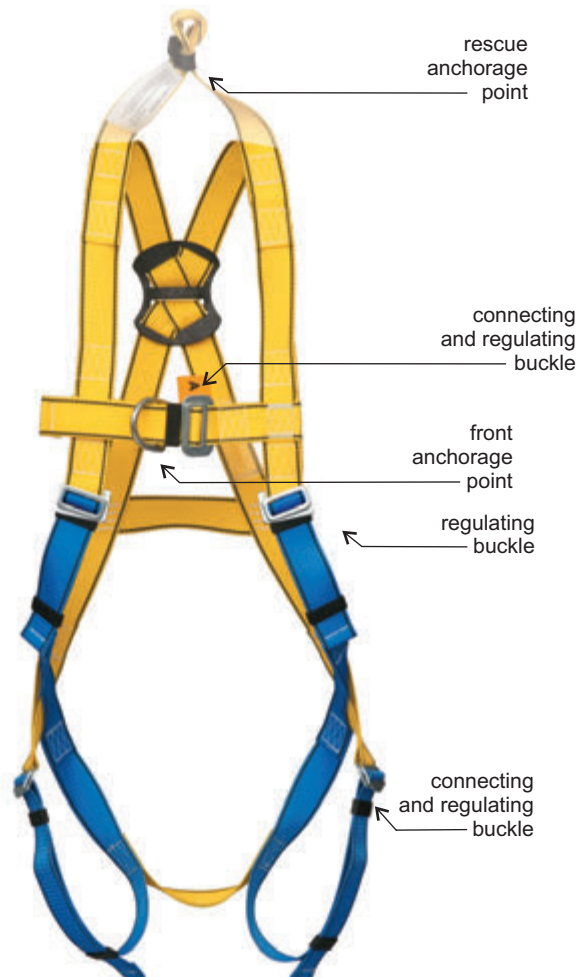

rescue anchorage point

connecting and regulating buckle

front anchorage point

regulating buckle

connecting and regulating buckle

Safety harness



P-14R SAFETY HARNESS **NEW!**

EN 361 EN 1497



Ref.: AB 114 01

Harness with front anchorage point.

Size: M-XL - 1600g

XXL - 1720g

Separate regulation for legs and shoulders straps.



P-15E SAFETY HARNESS **NEW!**

EN 361



Ref.: AB 115 02

Harness with dorsal anchorage point.

Size: M-XL - 1200g

XXL - 1300g

Separate regulation for legs and shoulders straps.



ELASTIC WEBBING

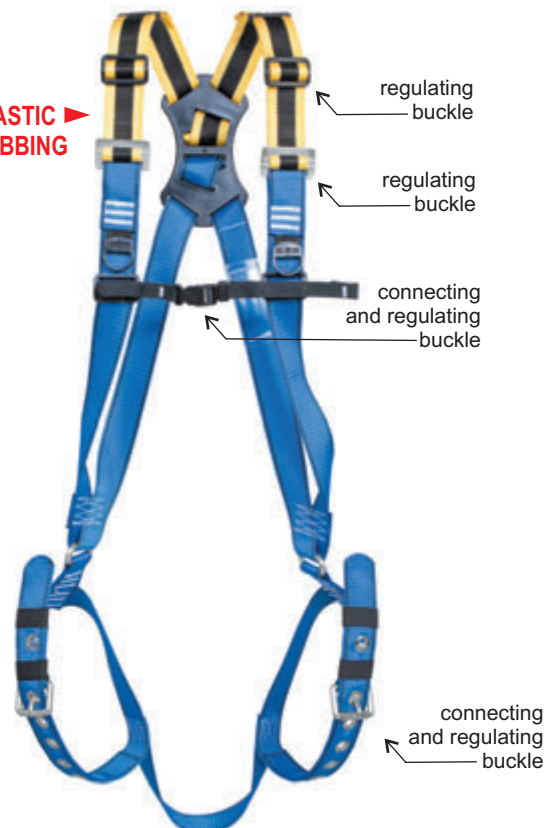

Safety harness

P-40 SAFETY HARNESS

EN 361



Ref.: AB 140 01

Harness with dorsal and front anchorage points.

Size: M-XL - 1150g
XXL - 1200g

Separate regulation for legs and shoulders straps.

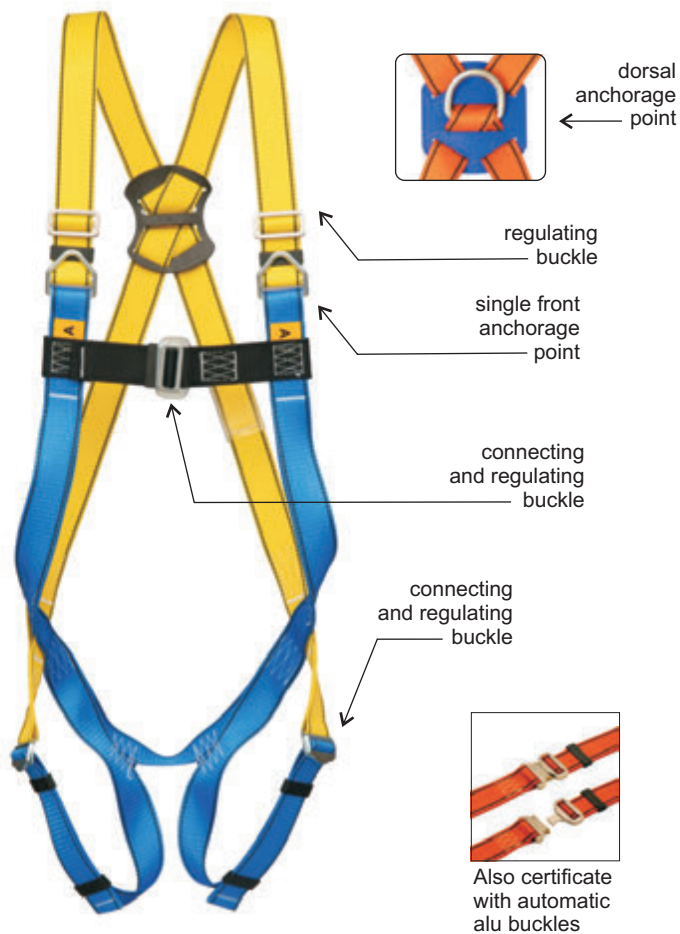

P-40A SAFETY HARNESS

EN 361



Ref.: AB 141 01

ALL BUCKLES - STAINLESS STEEL



Also certificate with automatic alu buckles

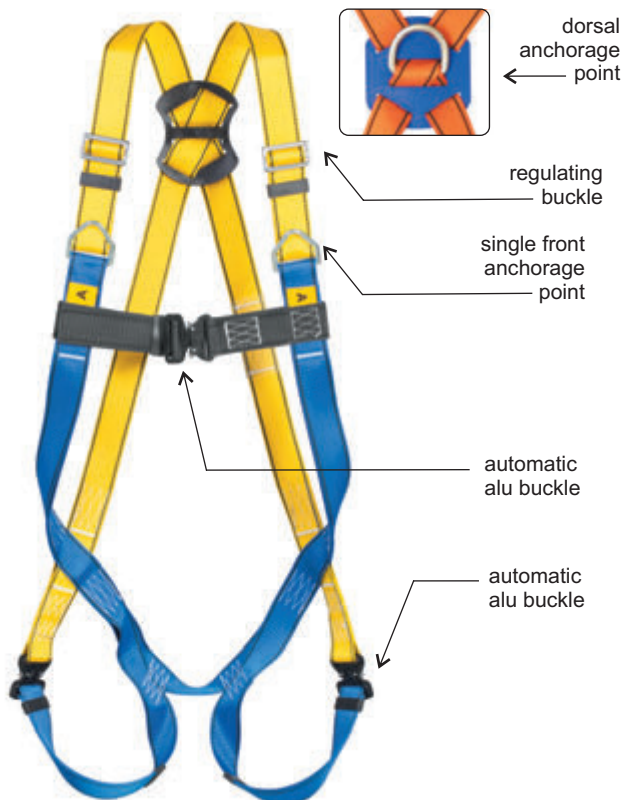

P-40C SAFETY HARNESS

EN 361



Ref.: AB 135 01

Harness with dorsal and front anchorage points.

Size: M-XL - 1190g
XXL - 1240g

Separate regulation for legs and shoulders straps.



Safety harness

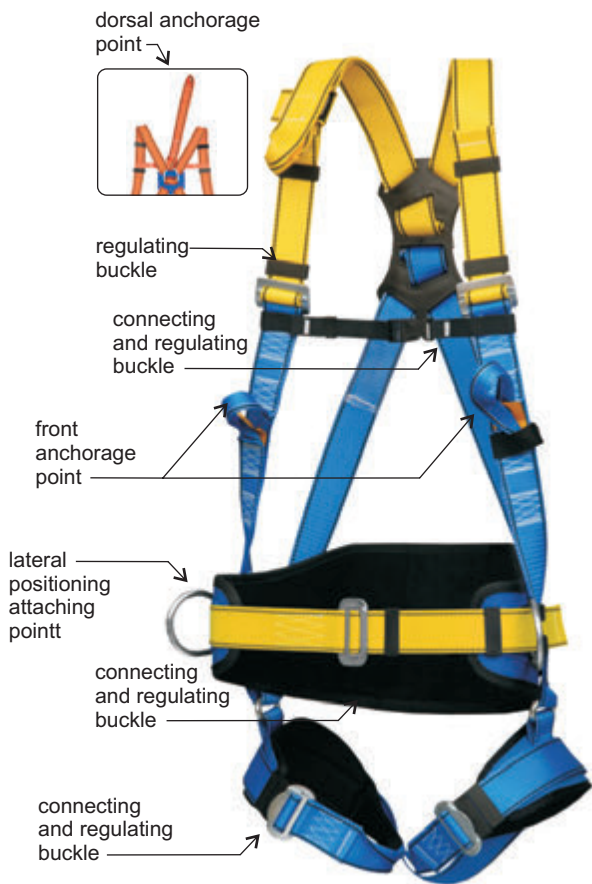

P-60 SAFETY HARNESS

EN 361 EN 358



Ref.: AB 160 01

Harness with front and dorsal anchorage point.

Work positioning belt.

Size: M-XL - 1540g

XXL - 1680g

Separate regulation for legs and shoulders straps.



Also certificate with automatic alu buckles

P-61 SAFETY HARNESS

EN 361 EN 358



Ref.: AB 161 01

Harness with front and dorsal anchorage point.

Work positioning belt.

Size: M-XL - 1720g

XXL - 1870g

Separate regulation for legs and shoulders straps.



Also certificate with automatic alu buckles

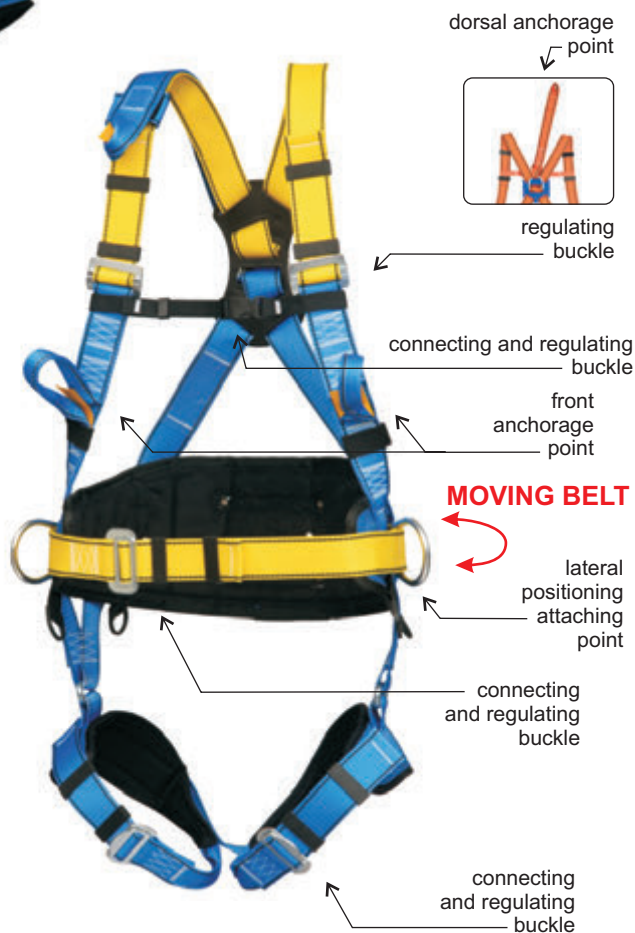

Safety harness



P-60E SAFETY HARNESS

EN 361 EN 358



Ref.: AB 160 02

Harness with front and dorsal anchorage point.

Work positioning belt.

Size: M-XL - 1740g

XXL - 1880g

Separate regulation for legs and shoulders straps.



Also certificate with automatic alu buckles

P-61E SAFETY HARNESS

EN 361 EN 358



Ref.: AB 161 02

Harness with front and dorsal anchorage point.

Work positioning belt.

Size: M-XL - 1880g

XXL - 1960g

Separate regulation for legs and shoulders straps.



Also certificate with automatic alu buckles



Safety harness

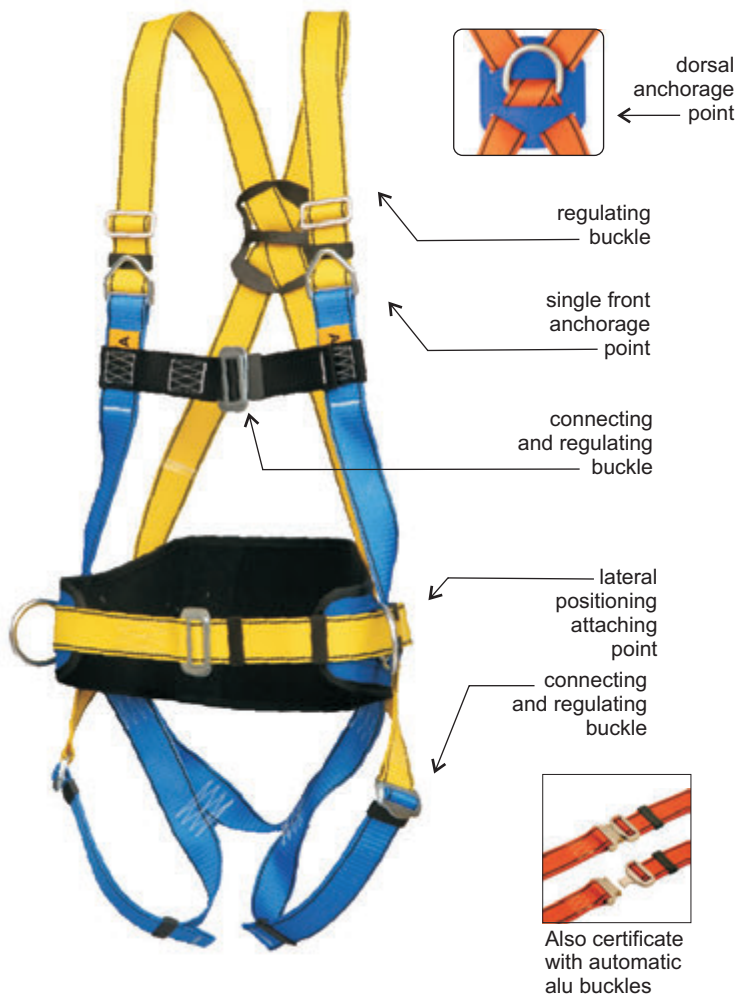

P-42 SAFETY HARNESS **NEW!**

EN 361 EN 358



Ref.: AB 142 01

Harness with dorsal and front anchorage points and work positioning belt.

Size: M-XL - 1530g

XXL - 1750g

Separate regulation for legs and shoulders straps.



P-51E SAFETY HARNESS

EN 361 EN 358



Ref.: AB 151 02

Harness with front and dorsal anchorage point.

Work positioning belt.

Size: M-XL - 1880g

XXL - 1960g

Separate regulation for legs and shoulders straps.



Safety harness

P-12 PRO SAFETY HARNESS

EN 361



Ref.: AB 112 01

Size: M-XL - 1115g
XXL - 1165g

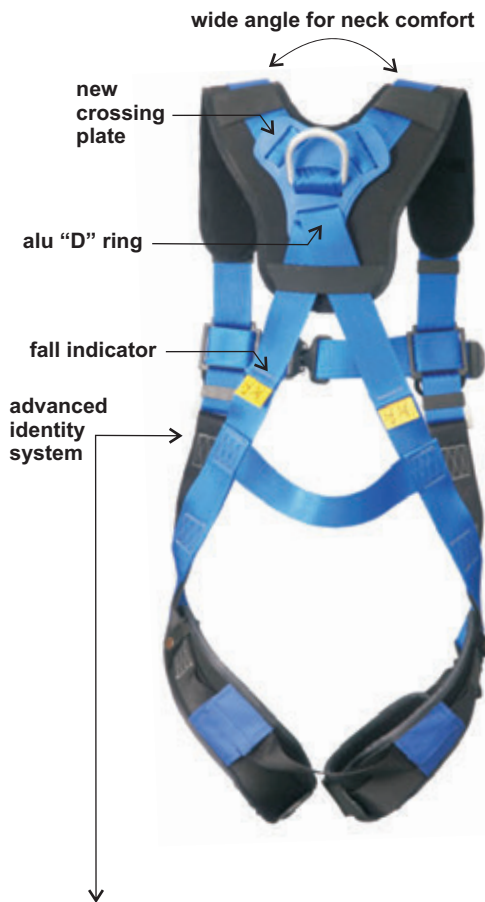

Individual Identity System

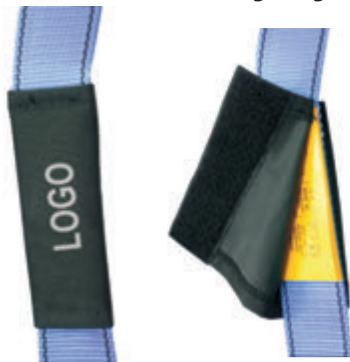

available standard and with logo



other available colours



Safety harness

P-22 PRO SAFETY HARNESS

EN 361 EN 358



Ref.: AB 122 01

Size: M-XL - 1450g
XXL - 1550g



Individual Identity System



available standard and with logo



other available colours



Safety harness

P-32 PRO SAFETY HARNESS

EN 361



Ref.: AB 132 01

Size: M-XL - 1315g
XXL - 1365g

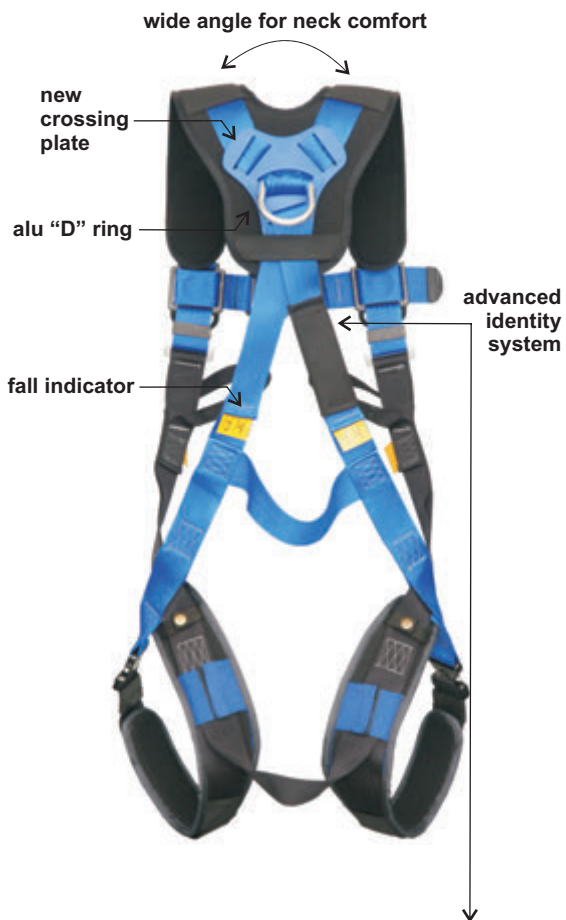

Individual Identity System

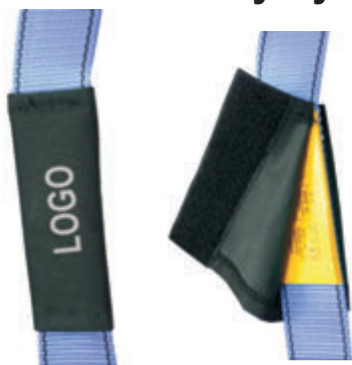

available standard and with logo

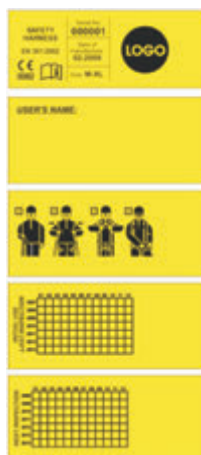

other available colours



Safety harness

P-52 PRO SAFETY HARNESS

EN 361 EN 358



Ref.: AB 152 01

Size: M-XL - 1650g

XXL - 1750g



Individual Identity System



available standard and with logo



other available colours



Safety harness

P-70 SAFETY HARNESS

EN 361 EN 358 EN 813



Ref.: AB 170 01

Harness with front and dorsal anchorage point.

Work positioning belt.

Size: M-XL - 1660g

XXL - 1760g

Separate regulation for legs and shoulders straps.



Also certificate with automatic alu buckles



other available colours



P-71E SAFETY HARNESS

EN 361 EN 358 EN 813



Ref.: AB 171 02

Harness with front and dorsal anchorage point.

Work positioning belt.

Size: M-XL - 1720g

XXL - 1820g

Separate regulation for legs and shoulders straps.



Safety harness

New construction!

P-71 comfort SAFETY HARNESS

EN 361 EN 358 EN 813



Ref.: AB 171 01

Harness with front and dorsal anchorage point. Attaching point for sitting position. Work positioning belt. **Aluminium buckle.**

Size: M-XL - 2050g

XXL - 2150g

Separate regulation for legs and shoulders

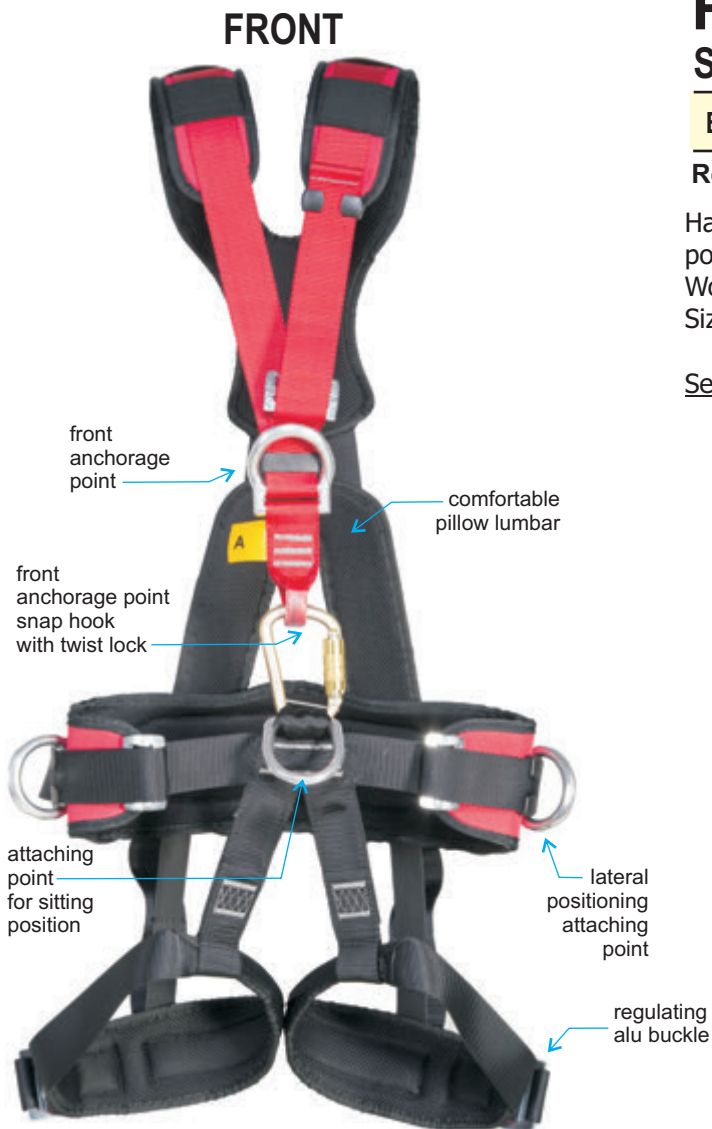

COMFORTABLE PILLOW LUMBAR

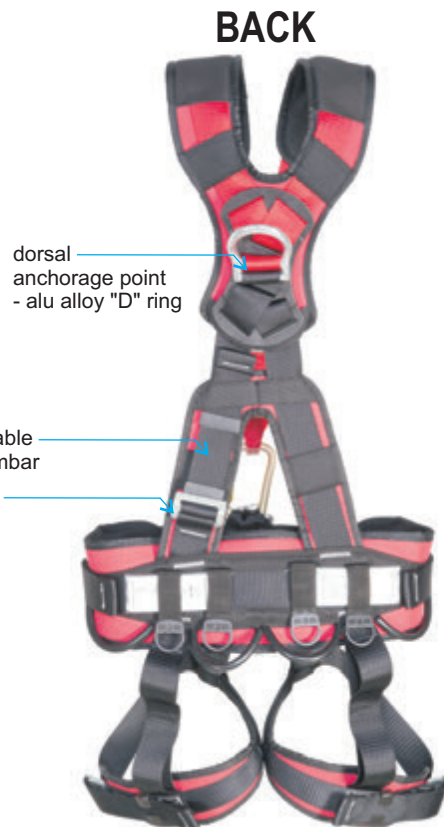

Safety harness

P-80 SAFETY HARNESS

EN 361 EN 358 EN 813



Ref.: AB 180 01

Harness with front and dorsal anchorage point. Attaching point for sitting position. Work positioning belt.

Size: M-XL - 1720g
XXL - 1800g

One regulation for legs and shoulders straps.

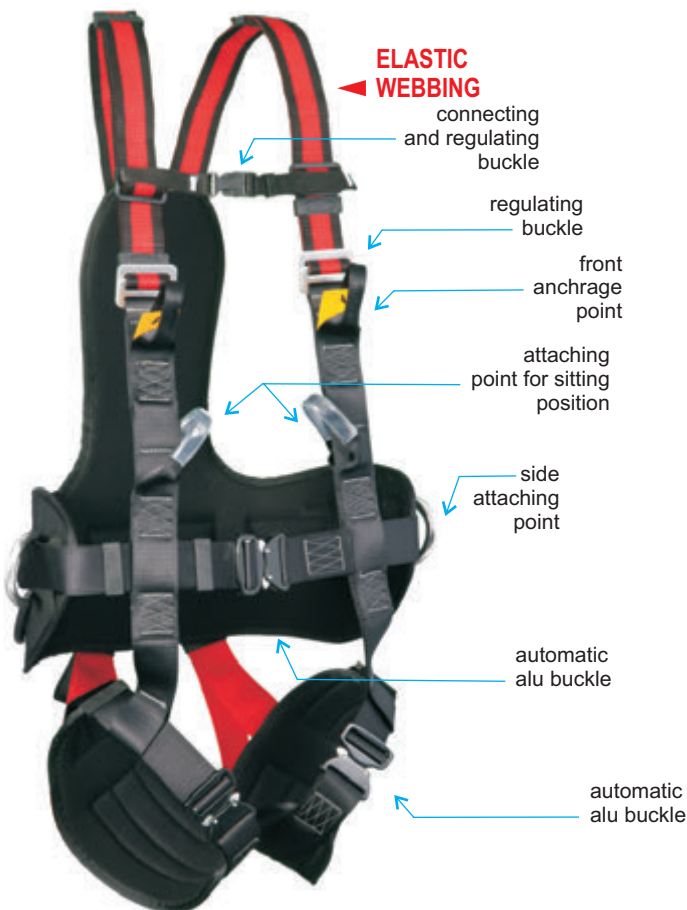
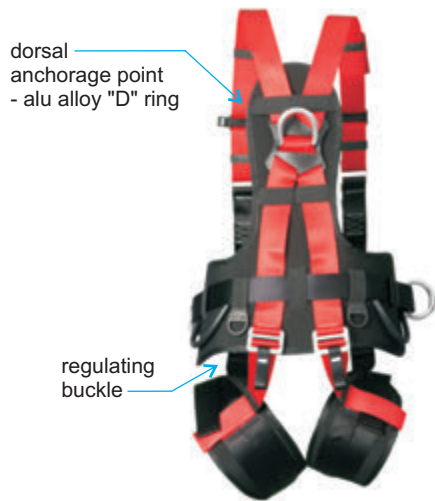

P-80E SAFETY HARNESS

EN 361 EN 358 EN 813



Ref.: AB 180 02

Harness with front and dorsal anchorage point. Attaching point for sitting position. Work positioning belt.

Size: M-XL - 1780g
XXL - 1860g

One regulation for legs and shoulders straps.



Safety harness

P-71C *New construction!* SAFETY HARNESS

EN 361 EN 358 EN 813



Ref.: AB 171 03

Harness with front and dorsal anchorage point. Attaching point for sitting position. Work positioning belt.

Size: M-XL - 1690g
XXL - 1790g

Separate regulation for legs and shoulders

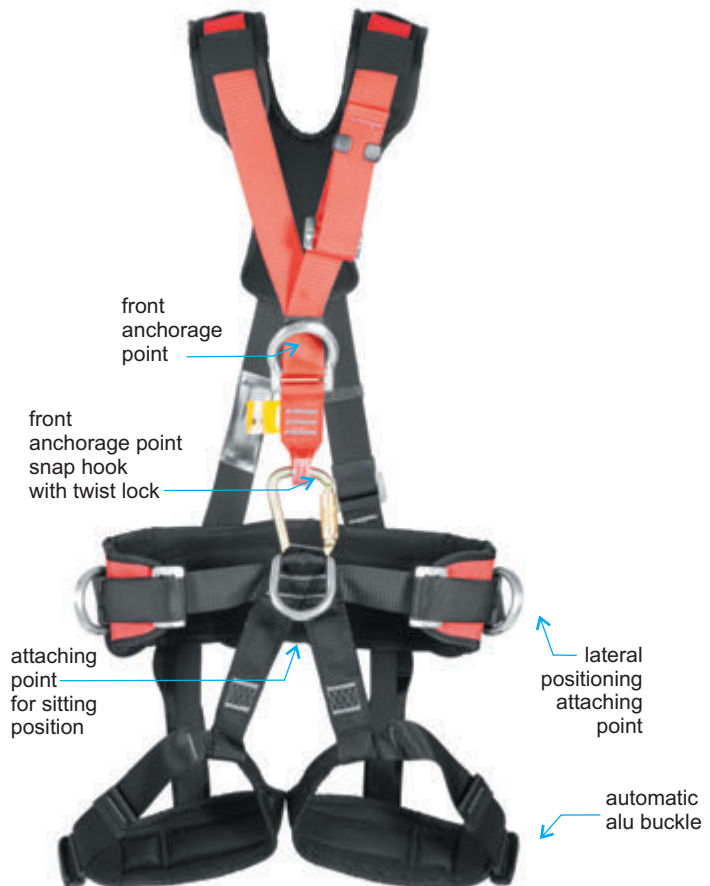

P-71CR *New construction!* SAFETY HARNESS

EN 361 EN 358 EN 813 EN 1497



Ref.: AB 171 05

Harness with front and dorsal anchorage point. Attaching point for sitting position. Work positioning belt.

Size: M-XL - 1720g
XXL - 1820g

Separate regulation for legs and shoulders straps.



Safety harness

P-73 *New construction!* SAFETY HARNESS

EN 361 EN 358 EN 813



Ref.: AB 173 03

Harness with front and dorsal anchorage point. Attaching point for sitting position. Work positioning belt.

Size: M-XL - 1780g
XXL - 1890g

Separate regulation for legs and shoulders

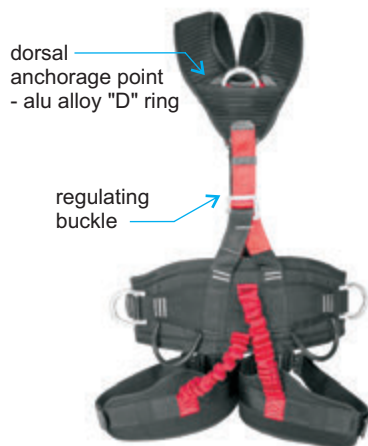

Possibility to connect the clamping device.



P-86R *New construction!* SAFETY HARNESS

EN 361 EN 358 EN 1497



Ref.: AB 186 01

Harness with front and dorsal anchorage point. Attaching point for sitting position. Work positioning belt.

Size: M-XL - 1820g
XXL - 1960g

Separate regulation for legs and shoulders straps.



Isolating safety harness



P-51E ISOL NEW! SAFETY HARNESS

EN 361 EN 358



Ref.: AB 151 03

Harness with front and dorsal anchorage point.

Work positioning belt.

Size: M-XL - 1790g

XXL - 1950g

Separate regulation for legs and shoulders straps.

P-80E ISOL NEW! SAFETY HARNESS

EN 361 EN 358 EN 813



Ref.: AB 180 03

Harness with front and dorsal anchorage point. Attaching point for sitting position.

Work positioning belt.

Size: M-XL - 1800g

XXL - 1880g

One regulation for legs and shoulders straps.



Safety harness

P-81 SAFETY HARNESS

EN 361 EN 358 EN 813



Ref.: AB 181 01

Harness with front and dorsal anchorage point. Attaching point for sitting position. Work positioning belt.

Size: M-XL - 1900g
XXL - 1980g

One regulation for legs and shoulders straps.

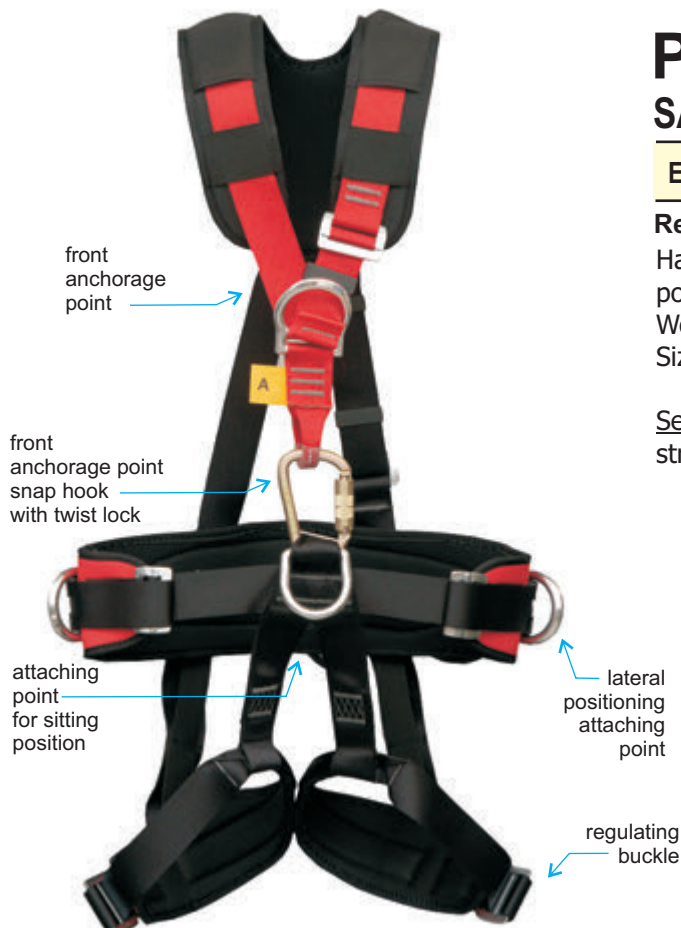
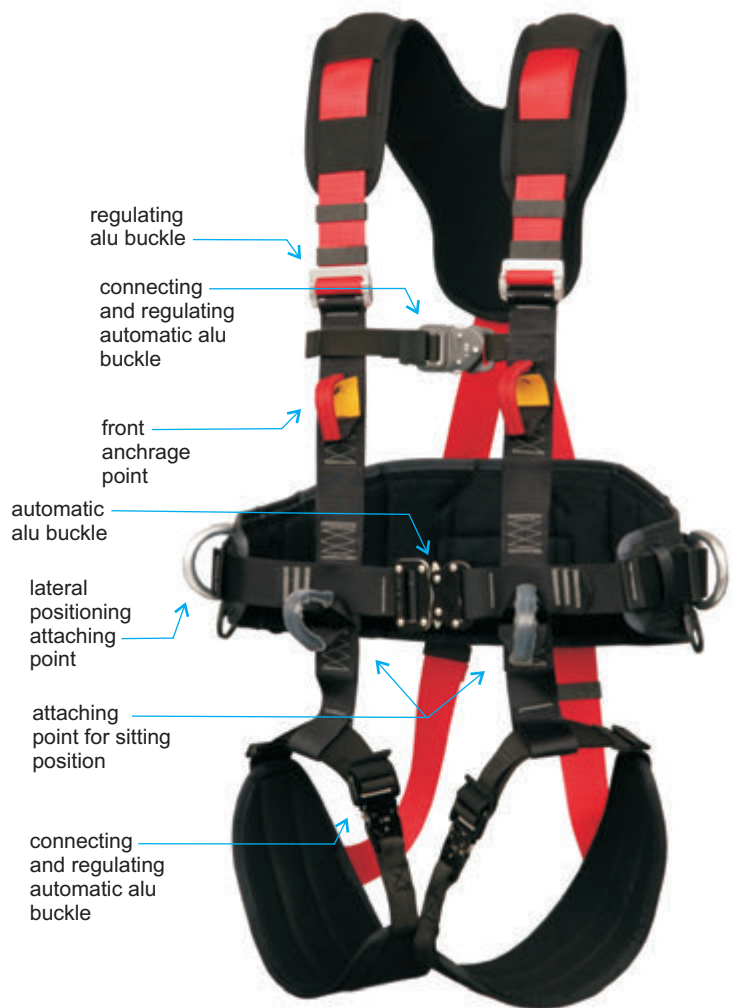
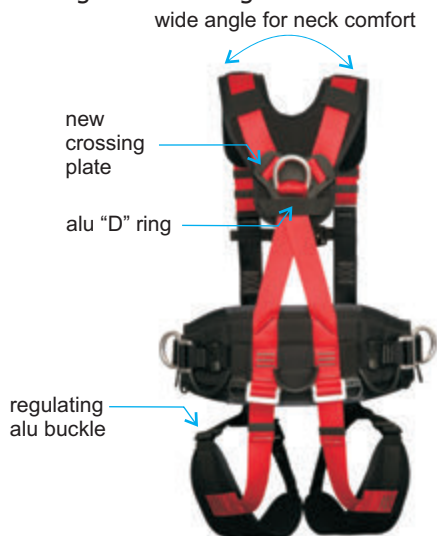

P-71 *New construction!* SAFETY HARNESS

EN 361 EN 358 EN 813



Ref.: AB 171 01

Harness with front and dorsal anchorage point. Attaching point for sitting position. Work positioning belt.

Size: M-XL - 1660g
XXL - 1760g

Separate regulation for legs and shoulders straps.



Safety harness

P-90 *New construction!* SAFETY HARNESS

EN 361 EN 358 EN 813



Ref.: AB 190 01

Harness with front and dorsal anchorage point. Attaching point for sitting position. Work positioning belt.

Size: M-XL - 1950g
XXL - 2030g

One regulation for legs and shoulders straps.

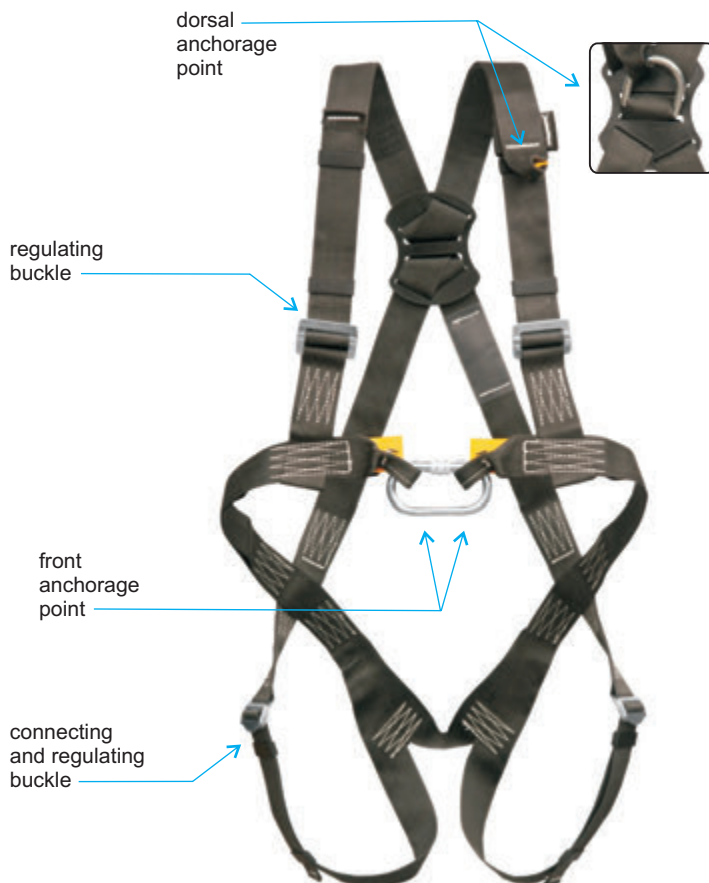
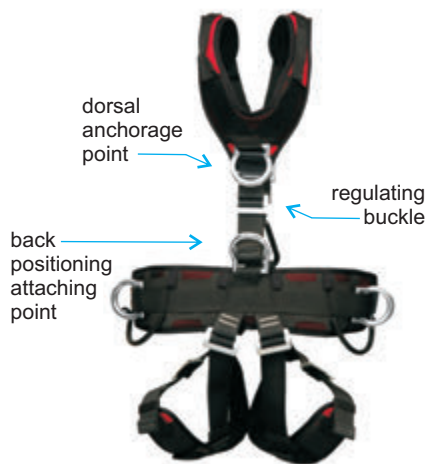

P-30N SAFETY HARNESS NEW MODEL NON-FLAMMABLE

EN 361



Ref.: AB 131 01

Harness with front and dorsal anchorage point. **ARAMID-POLYESTER** webbing.

Size: M-XL - 1030g
XXL - 1090g

Separate regulation for legs and shoulders straps.

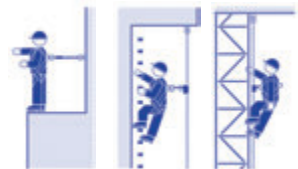

ATTENTION:

For hot works
like welding,
grinding, soldering
metal cutting.

The rope is protected
against sparks,
molten metal drops, etc.

EN 358 p.4.1.5
resistance to flame



Safety harness

P-50N ISOL NEW! SAFETY HARNESS NEW MODEL NON-FLAMMABLE

EN 361 EN 358



Ref.: AB 151 03

Harness with front and dorsal anchorage point. **ARAMID-POLYESTER** webbing.

Size: M-XL - 1690g
XXL - 1790g

Separate regulation for legs and shoulders straps.



ATTENTION:

For hot works like welding, grinding, soldering metal cutting.

The rope is protected against sparks, molten metal drops, etc.

EN 358 p.4.1.5
resistance to flame



P-50N NEW! SAFETY HARNESS NEW MODEL NON-FLAMMABLE

EN 361



Ref.: AB 151 01

Harness with front and dorsal anchorage point. **ARAMID-POLYESTER** webbing.

Size: M-XL - 1650g
XXL - 1750g

Separate regulation for legs and shoulders straps.



ATTENTION:

For hot works like welding, grinding, soldering metal cutting.

The rope is protected against sparks, molten metal drops, etc.

EN 358 p.4.1.5
resistance to flame



Safety harness

For Women!

P-10F

Women's HARNESSSES

EN 361



Ref.: AB 110 04

Harness with dorsal anchorage point.

Size: M-XL - 1050g

XXL - 1150g

One regulation for legs and shoulders straps.

dorsal anchorage point



automatic alu buckle

connecting and regulating buckle



dorsal anchorage point



Safety harness with vest



P-30HV+ HIGH VISIBLE SAFETY HARNESS WITH VEST

EN 361



Ref.: AB 130 04



Harness with front and dorsal anchorage point.

Size: M-XL - 1000g
XXL - 1060g

Separate regulation for legs and shoulders straps.



Available colors:

-  Hi Viz orange
-  Hi Viz yellow

P-50HV+ HIGH VISIBLE SAFETY HARNESS WITH VEST

EN 361



Ref.: AB 150 04

Harness with front and dorsal anchorage point.



Work positioning belt.

Size: M-XL - 1460g
XXL - 1600g

Separate regulation for legs and shoulders straps.



Available colors:

-  Hi Viz orange
-  Hi Viz yellow

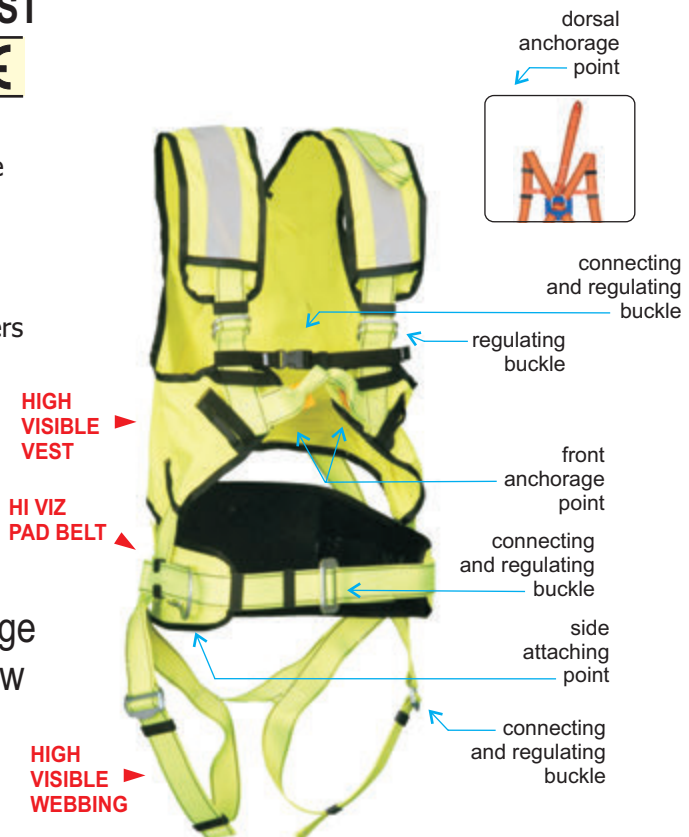

Safety harness with vest

Hi Viz orange

FRONT



BACK



P-04

HIGH VISIBLE

SAFETY HARNESS WITH VEST

EN 361



Ref.: AB 104 04

Harness with front and dorsal anchorage point.

Size: M-XL
XXL

Separate regulation for legs and shoulders straps.

Hi Viz green-yellow

FRONT



BACK



Safety harness with vest



P-03 + VS041 SAFETY HARNESS with VEST

EN 361



Ref.: AB 103 01

Comfortable protective vest with safety harness.

Harness with front and dorsal anchorage point.

Size: M-XL - 725g
XXL - 735g

One regulation for legs and shoulders straps.

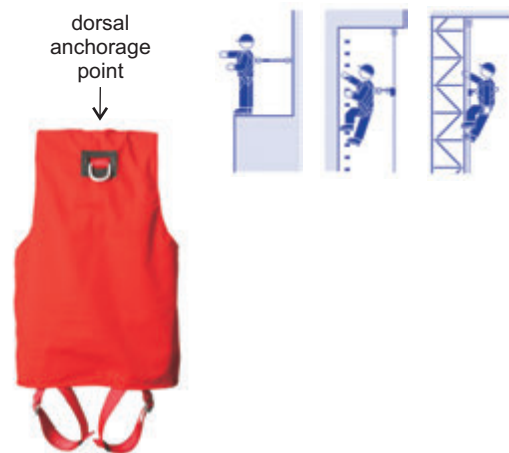

P-30 + VS041 SAFETY HARNESS with VEST

EN 361



Ref.: AB 130 01

Comfortable protective vest with safety harness.

Harness with front and dorsal anchorage point.

Size: M-XL - 1035g
XXL - 1095g

Separate regulation for legs and shoulders straps.

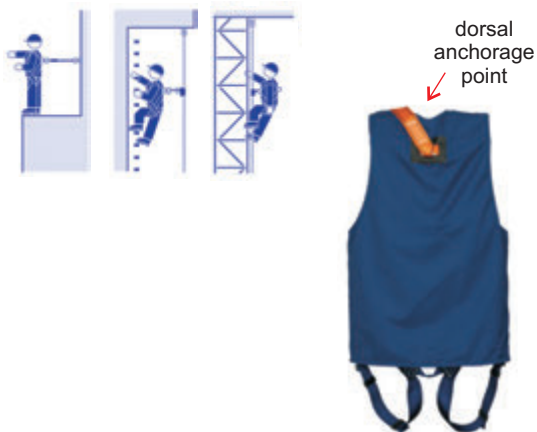

Jacket and safety harness

KB 040 high visible



KB 040, KB 041, KB 042 jacket with safety harness P-11 or P-11C **NEW!**

EN 361



Ref.: KB 040, KB 041, KB 042

Materials: 97% polyester, 3% elasthan

3 Layers:

- polyester bistrech fabric 1/1 plain weave (water repellent)
- TPU membrane
- micro polar fabric

Total weight: 350 +/- 5% gsm (without harness).

Properties: water repellency, water resist



3 LAYERS

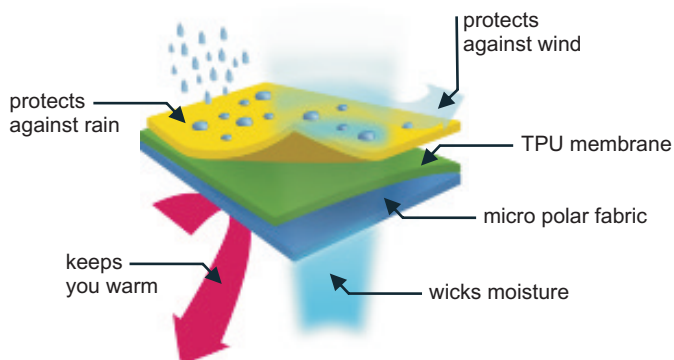

Overalls sizes:

SIZE	HEIGHT	CHEST MEASUREMENT
M 38-40	176/179 cm	83-94 cm
L 38-40	179/182 cm	95-102 cm
XL 38-40	182/185 cm	103-112 cm

KB 040, KB 041, KB 042 with P-11
KB 040, KB 041, KB 042 with P-11C

Protective overalls with safety harness

OVERALLS KB 020

EN 361 

Comfortable overalls with safety harness inside

Construction and design

Dorsal attaching point up to standard EN 361:2002

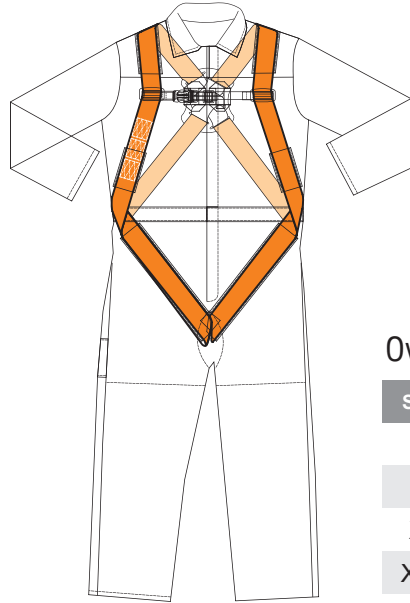

Overalls sizes: M, L, XL, XXL

SIZE	HEIGHT	CHEST MEASUREMENT	WAIST MEASUREMENT
M	170/176	96-100	80-84
L	176/182	104-108	88-92
XL	182/188	108-112	92-96
XXL	188/194	116-120	100-104

Safety harness | EN 361



Fabric and performance

Standard fabric / color

Polyester 65 % Cotton 35%
by KLOPMAN

	NEW EMPIRE RED WEIGHT 210 g/m ²
	BOTTLE GREEN WEIGHT 210 g/m ²
	COMBO BLUE WEIGHT 210 g/m ²
	BLACK WEIGHT 210 g/m ²

High Visible colors







Polyester 85 % Cotton 15%
Luminex H.V. by KLOPMAN

	Luminex H.V. Orange
	Luminex H.V. Yellow

Conforming to: EN 471:2008

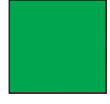
Flame Resistance and Anti-static fabric

Viscose FR, modified acrylic type F
XISPAL by LENARD

	Red WEIGHT 320 g/m ²		Royal Blue WEIGHT 320 g/m ²
	Green WEIGHT 320 g/m ²		Orange WEIGHT 320 g/m ²
	Grey 80 WEIGHT 320 g/m ²		Navy WEIGHT 320 g/m ²

EN 531 Protection for clothes against fire and heat
EN 366 Radiating Heat: Comply with C1 and C2
EN 367 Convective Heat: Comply with B1 and B2
EN 532 Limited flame speed: Comply with A
EN V50354 Protection against electric arc:
Comply with TYPE 1,4 kA
EN373 Protection against extensive
splashing from molten iron and aluminium
EN 348 Protection against light splashing from molten metals
EN 1149 Anti-static Regulations

Flame Resistance, Anti-static fabric and High Visible standards

	HV Yellow WEIGHT 270 g/m ²
---	--

Conforming to: EN 471:2008



XISPAL[®]
SAFETY JOB

Energy absorbers

AZ 002
galvanized steel
opening: 18 mm
weight: 220 g



AZ 003
aluminium
opening: 20 mm
weight: 160 g



AZ 004
aluminium
opening: 22 mm
weight: 180 g
twist lock



AZ 040
aluminium
opening: 23 mm
weight: 80 g



AZ 041T
aluminium
opening: 23 mm
weight: 100 g
twist lock



AZ 020
galvanized steel
opening: 23 mm
weight: 230 g



AZ 021T
galvanized steel
opening: 23 mm
weight: 250 g
twist lock



AZ 022
galvanized steel
opening: 50 mm
weight: 500 g



AZ 023
aluminium
opening: 60 mm
weight: 480 g



AZ 024
aluminium
opening: 100 mm
weight: 920 g



AZ 025
galvanized steel
opening: 80 mm
weight: 800 g



ABM ENERGY ABSORBER

EN 355



Ref.: BW 200

Dimensions: 160x35x45mm.

Weight: 160g.

Material: Polyamide 100%.

Energy absorbers

AZ 002
galvanized steel
opening: 18 mm
weight: 220 g



AZ 003
aluminium
opening: 20 mm
weight: 160 g



AZ 004
aluminium
opening: 22 mm
weight: 180 g
twist lock



AZ 040
aluminium
opening: 23 mm
weight: 80 g



AZ 041T
aluminium
opening: 23 mm
weight: 100 g
twist lock



AZ 020
galvanized steel
opening: 23 mm
weight: 230 g



AZ 021T
galvanized steel
opening: 23 mm
weight: 250 g
twist lock



AZ 022
galvanized steel
opening: 50 mm
weight: 500 g



AZ 023
aluminium
opening: 60 mm
weight: 480 g



AZ 024
aluminium
opening: 100 mm
weight: 920 g



AZ 025
galvanized steel
opening: 80 mm
weight: 800 g



loop

loop

energy absorber
ABM

safety lanyard
LB 100 - Ø 12mm
or
LB 140 - Ø 14mm

ABM+LB 100

energy absorber with universal adjustable safety lanyard Ø12 mm

EN 355 EN 354



Ref.: BW 200+LB 100

Max. length: 2m (included connected snap hooks).

Material: Polyamide.

OTHER LENGHTES ON REQUEST

◀ ROPE
Ø 12mm



ABM+LB 140

energy absorber with universal adjustable safety lanyard Ø 14 mm

EN 355 EN 354



Ref.: BW 200+LB 140

Max. length: 2m (included connected snap hooks).

Material: Polyamide.

OTHER LENGHTES ON REQUEST

◀ ROPE
Ø 14mm



Energy absorbers

AZ 002
galvanized steel
opening: 18 mm
weight: 220 g



AZ 003
aluminium
opening: 20 mm
weight: 160 g



AZ 004
aluminium
opening: 22 mm
weight: 180 g
twist lock



AZ 040
aluminium
opening: 23 mm
weight: 80 g



AZ 041T
aluminium
opening: 23 mm
weight: 100 g
twist lock



AZ 020
galvanized steel
opening: 23 mm
weight: 230 g



AZ 021T
galvanized steel
opening: 23 mm
weight: 250 g
twist lock



AZ 022
galvanized steel
opening: 50 mm
weight: 500 g



AZ 023
aluminium
opening: 60 mm
weight: 480 g



AZ 024
aluminium
opening: 100 mm
weight: 920 g



AZ 025
galvanized steel
opening: 80 mm
weight: 800 g



ABM+ 2LB 100

energy absorber with double universal adjustable safety lanyard $\varnothing 12$ mm

EN 355 EN 354



Ref.: BW 200+2LB 100

Max. length: 2m (included connected snap hooks).

Material: Polyamide.

OTHER LENGHTES ON REQUEST



ROPE $\varnothing 12$ mm

ABM+2LB 140

energy absorber with double universal adjustable safety lanyard $\varnothing 14$ mm

EN 355 EN 354



Ref.: BW 200+2LB 140

Max. length: 2m (included connected snap hooks).

Material: Polyamide.

OTHER LENGHTES ON REQUEST



ROPE $\varnothing 14$ mm

Energy absorbers

AZ 002
galvanized steel
opening: 18 mm
weight: 220 g



AZ 003
aluminium
opening: 20 mm
weight: 160 g



AZ 004
aluminium
opening: 22 mm
weight: 180 g
twist lock



AZ 040
aluminium
opening: 23 mm
weight: 80 g



AZ 041T
aluminium
opening: 23 mm
weight: 100 g
twist lock



AZ 020
galvanized steel
opening: 23 mm
weight: 230 g



AZ 021T
galvanized steel
opening: 23 mm
weight: 250 g
twist lock



AZ 022
galvanized steel
opening: 50 mm
weight: 500 g



AZ 023
aluminium
opening: 60 mm
weight: 480 g



AZ 024
aluminium
opening: 100 mm
weight: 920 g



AZ 025
galvanized steel
opening: 80 mm
weight: 800 g



loop

energy absorber
ABM

safety lanyard
LB 101 - Ø 10,5mm
or
LB 121 - Ø 12mm
or
LB 141 - Ø 14mm

ABM+LB 101

energy absorber with
universal safety lanyard $\varnothing 10,5$ mm

EN 355 EN 354



Ref.: BW 200+LB 101

Max. length: 2m (included connected snap hooks).

Material: Polyamide.

OTHER LENGHTES ON REQUEST

ROPE
 $\varnothing 10,5$ mm

ABM+LB 121

energy absorber with
universal safety lanyard $\varnothing 12$ mm

EN 355 EN 354



Ref.: BW 200+LB 121

Max. length: 2m (included connected snap hooks).

Material: Polyamide.

OTHER LENGHTES ON REQUEST

ROPE
 $\varnothing 12$ mm

ABM+LB 141

energy absorber with
universal safety lanyard $\varnothing 14$ mm

EN 355 EN 354



Ref.: BW 200+LB 141

Weight: 000g.

Max. length: 2m (included connected snap hooks).

Material: Polyamide.

OTHER LENGHTES ON REQUEST

ROPE
 $\varnothing 14$ mm

Energy absorbers

AZ 002
galvanized steel
opening: 18 mm
weight: 220 g



AZ 003
aluminium
opening: 20 mm
weight: 160 g



AZ 004
aluminium
opening: 22 mm
weight: 180 g
twist lock



AZ 040
aluminium
opening: 23 mm
weight: 80 g



AZ 041T
aluminium
opening: 23 mm
weight: 100 g
twist lock



AZ 020
galvanized steel
opening: 23 mm
weight: 230 g



AZ 021T
galvanized steel
opening: 23 mm
weight: 250 g
twist lock



AZ 022
galvanized steel
opening: 50 mm
weight: 500 g



AZ 023
aluminium
opening: 60 mm
weight: 480 g



AZ 024
aluminium
opening: 100 mm
weight: 920 g



AZ 025
galvanized steel
opening: 80 mm
weight: 800 g



energy absorber
ABM

safety lanyard
LB 102 - Ø 10,5mm
or
LB 122 - Ø 12mm

ABM+LB 102

energy absorber
with double safety lanyard

EN 355 EN 354



Ref.: BW 200+LB 102

Max. length: 2x2m (included connected snap hooks).
Material: Polyamide.

OTHER LENGHTES ON REQUEST

◀ ROPE
Ø 10,5mm

ABM+LB 122

energy absorber
with double safety lanyard

EN 355 EN 354



Ref.: BW 200+LB 122

Max. length: 2x2m (included connected snap hooks).
Material: Polyamide.

OTHER LENGHTES ON REQUEST

◀ ROPE
Ø 12,mm

Energy absorbers

AZ 002
galvanized steel
opening: 18 mm
weight: 220 g



AZ 003
aluminium
opening: 20 mm
weight: 160 g



AZ 004
aluminium
opening: 22 mm
weight: 180 g
twist lock



AZ 040
aluminium
opening: 23 mm
weight: 80 g



AZ 041T
aluminium
opening: 23 mm
weight: 100 g
twist lock



AZ 020
galvanized steel
opening: 23 mm
weight: 230 g



AZ 021T
galvanized steel
opening: 23 mm
weight: 250 g
twist lock



AZ 022
galvanized steel
opening: 50 mm
weight: 500 g



AZ 023
aluminium
opening: 60 mm
weight: 480 g



AZ 024
aluminium
opening: 100 mm
weight: 920 g



AZ 025
galvanized steel
opening: 80 mm
weight: 800 g



ABM-T energy absorber with webbing

EN 355, EN 354



Ref.: BW 700

Max. length: 2m (included connected snap hooks).
Material: Polyamide.

OTHER LENGHTES ON REQUEST

Energy absorbers

AZ 002
galvanized steel
opening: 18 mm
weight: 220 g



AZ 003
aluminium
opening: 20 mm
weight: 160 g



AZ 004
aluminium
opening: 22 mm
weight: 180 g
twist lock



AZ 040
aluminium
opening: 23 mm
weight: 80 g



AZ 041T
aluminium
opening: 23 mm
weight: 100 g
twist lock



AZ 020
galvanized steel
opening: 23 mm
weight: 230 g



AZ 021T
galvanized steel
opening: 23 mm
weight: 250 g
twist lock



AZ 022
galvanized steel
opening: 50 mm
weight: 500 g



AZ 023
aluminium
opening: 60 mm
weight: 480 g



AZ 024
aluminium
opening: 100 mm
weight: 920 g



AZ 025
galvanized steel
opening: 80 mm
weight: 800 g



ABM-2T energy absorber with double webbing

EN 355, EN 354



Ref.: BW 800

Max. length: 2x2m (included connected snap hooks).
Material: Polyamide.

OTHER LENGHTES ON REQUEST

Energy absorbers

AZ 002
galvanized steel
opening: 18 mm
weight: 220 g



AZ 003
aluminium
opening: 20 mm
weight: 160 g



AZ 004
aluminium
opening: 22 mm
weight: 180 g
twist lock



AZ 040
aluminium
opening: 23 mm
weight: 80 g



AZ 041T
aluminium
opening: 23 mm
weight: 100 g
twist lock



AZ 020
galvanized steel
opening: 23 mm
weight: 230 g



AZ 021T
galvanized steel
opening: 23 mm
weight: 250 g
twist lock



AZ 022
galvanized steel
opening: 50 mm
weight: 500 g



AZ 023
aluminium
opening: 60 mm
weight: 480 g



AZ 024
aluminium
opening: 100 mm
weight: 920 g



AZ 025
galvanized steel
opening: 80 mm
weight: 800 g



← loop

← loop

← energy absorber
ABM

← elastic safety lanyard
LE 101

ABM+LE 101 energy absorber with elastic safety lanyard

EN 355 EN 354



Ref.: BW 200+LE 101

Max. length: 2m (included connected snap hooks).
Material: Polyamide.

OTHER LENGHTES ON REQUEST

Energy absorbers

AZ 002
galvanized steel
opening: 18 mm
weight: 220 g



AZ 003
aluminium
opening: 20 mm
weight: 160 g



AZ 004
aluminium
opening: 22 mm
weight: 180 g
twist lock



AZ 040
aluminium
opening: 23 mm
weight: 80 g



AZ 041T
aluminium
opening: 23 mm
weight: 100 g
twist lock



AZ 020
galvanized steel
opening: 23 mm
weight: 230 g



AZ 021T
galvanized steel
opening: 23 mm
weight: 250 g
twist lock



AZ 022
galvanized steel
opening: 50 mm
weight: 500 g



AZ 023
aluminium
opening: 60 mm
weight: 480 g



AZ 024
aluminium
opening: 100 mm
weight: 920 g



AZ 025
galvanized steel
opening: 80 mm
weight: 800 g

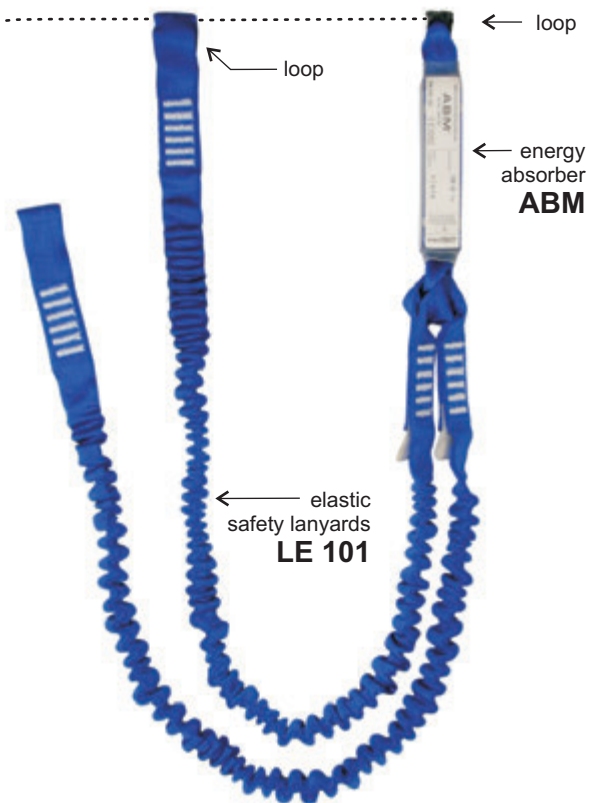

ABM+2LE 101 energy absorber with double elastic safety lanyard

EN 355 EN 354



Ref.: BW 200+2LE 101

Max. length: 2m (included connected snap hooks).
Material: Polyamide.

OTHER LENGHTES ON REQUEST

Energy absorbers

AZ 002
galvanized steel
opening: 18 mm
weight: 220 g



AZ 003
aluminium
opening: 20 mm
weight: 160 g



AZ 004
aluminium
opening: 22 mm
weight: 180 g
twist lock



AZ 040
aluminium
opening: 23 mm
weight: 80 g



AZ 041T
aluminium
opening: 23 mm
weight: 100 g
twist lock



AZ 020
galvanized steel
opening: 23 mm
weight: 230 g



AZ 021T
galvanized steel
opening: 23 mm
weight: 250 g
twist lock



AZ 022
galvanized steel
opening: 50 mm
weight: 500 g



AZ 023
aluminium
opening: 60 mm
weight: 480 g



AZ 024
aluminium
opening: 100 mm
weight: 920 g



AZ 025
galvanized steel
opening: 80 mm
weight: 800 g



LA 101 energy absorbing lanyard

EN 355



Ref.: LA 101 xx (xx - length)

Standards:

LA 101 12 - length 1,2 m

LA 101 16 - length 1,6 m

Material: Polyamide.

OTHER LENGHTES ON REQUEST

Energy absorbers

Aramid rope

AZ 002
galvanized steel
opening: 18 mm
weight: 220 g



AZ 003
aluminium
opening: 20 mm
weight: 160 g



AZ 004
aluminium
opening: 22 mm
weight: 180 g
twist lock



AZ 040
aluminium
opening: 23 mm
weight: 80 g



AZ 041T
aluminium
opening: 23 mm
weight: 100 g
twist lock



AZ 020
galvanized steel
opening: 23 mm
weight: 230 g



AZ 021T
galvanized steel
opening: 23 mm
weight: 250 g
twist lock



AZ 022
galvanized steel
opening: 50 mm
weight: 500 g



AZ 023
aluminium
opening: 60 mm
weight: 480 g



AZ 024
aluminium
opening: 100 mm
weight: 920 g



AZ 025
galvanized steel
opening: 80 mm
weight: 800 g

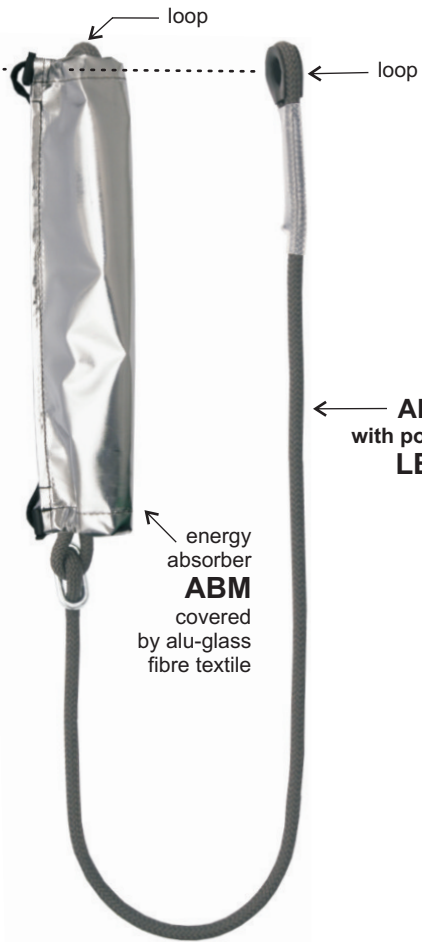

ABM+LB 200 FLR energy absorber with ADJUSTABLE safety lanyard

EN 355 EN 354



Ref.: BW 200+LB 200 FLR

Max. length: 2m (included connected snap hooks).
Material: Aramid rope with polyester core;

OTHER LENGHTES ON REQUEST

ATTENTION:

For hot works
like welding,
grinding, soldering
metal cutting.

The rope is protected
against sparks,
molten metal drops, etc.

EN 358 p.4.1.5
resistance to flame



Energy absorbers

Aramid rope

AZ 002
galvanized steel
opening: 18 mm
weight: 220 g



AZ 003
aluminium
opening: 20 mm
weight: 160 g



AZ 004
aluminium
opening: 22 mm
weight: 180 g
twist lock



AZ 040
aluminium
opening: 23 mm
weight: 80 g



AZ 041T
aluminium
opening: 23 mm
weight: 100 g
twist lock



AZ 020
galvanized steel
opening: 23 mm
weight: 230 g



AZ 021T
galvanized steel
opening: 23 mm
weight: 250 g
twist lock



AZ 022
galvanized steel
opening: 50 mm
weight: 500 g



AZ 023
aluminium
opening: 60 mm
weight: 480 g



AZ 024
aluminium
opening: 100 mm
weight: 920 g



AZ 025
galvanized steel
opening: 80 mm
weight: 800 g

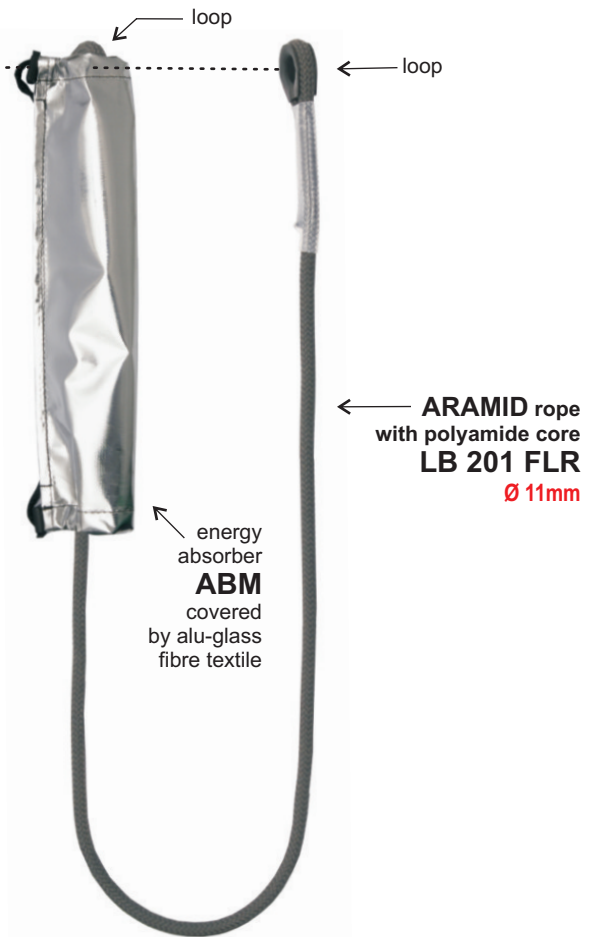

ABM+LB 201 FLR energy absorber with safety lanyard

EN 355 EN 354



Ref.: BW 200+LB 201 FLR

Max. length: 2m (included connected snap hooks).
Material: Aramid rope with polyester core;

OTHER LENGHTES ON REQUEST

ATTENTION:

For hot works
like welding,
grinding, soldering
metal cutting.

The rope is protected
against sparks,
molten metal drops, etc.

EN 358 p.4.1.5
resistance to flame



Energy absorbers

AZ 002
galvanized steel
opening: 18 mm
weight: 220 g



AZ 003
aluminium
opening: 20 mm
weight: 160 g



AZ 004
aluminium
opening: 22 mm
weight: 180 g
twist lock



AZ 040
aluminium
opening: 23 mm
weight: 80 g



AZ 041T
aluminium
opening: 23 mm
weight: 100 g
twist lock



AZ 020
galvanized steel
opening: 23 mm
weight: 230 g



AZ 021T
galvanized steel
opening: 23 mm
weight: 250 g
twist lock



AZ 022
galvanized steel
opening: 50 mm
weight: 500 g



AZ 023
aluminium
opening: 60 mm
weight: 480 g



AZ 024
aluminium
opening: 100 mm
weight: 920 g



AZ 025
galvanized steel
opening: 80 mm
weight: 800 g

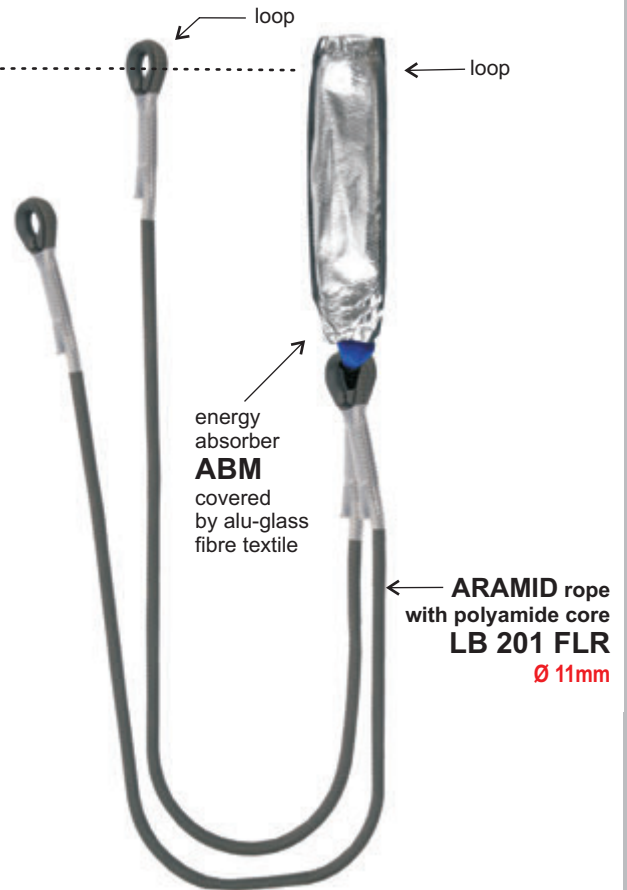

ABM+2LB 201 FLR energy absorber with double adjustable safety lanyard

EN 355 EN 354



Ref.: BW 200+2LB 201 FLR

Max. length: 2m (included connected snap hooks).
Material: Polyamide, hemp.

OTHER LENGHTES ON REQUEST

ATTENTION:

For hot works
like welding,
grinding, soldering
metal cutting.

The rope is protected
against sparks,
molten metal drops, etc.

EN 358 p.4.1.5
resistance to flame



Safety lanyards

AZ 002
galvanized steel
opening: 18 mm
weight: 220 g



AZ 003
aluminium
opening: 20 mm
weight: 160 g



AZ 004
aluminium
opening: 22 mm
weight: 180 g
twist lock



AZ 040
aluminium
opening: 23 mm
weight: 80 g



AZ 041T
aluminium
opening: 23 mm
weight: 100 g
twist lock



AZ 020
galvanized steel
opening: 23 mm
weight: 230 g



AZ 021T
galvanized steel
opening: 23 mm
weight: 250 g
twist lock



AZ 022
galvanized steel
opening: 50 mm
weight: 500 g



AZ 023
aluminium
opening: 60 mm
weight: 480 g



AZ 024
aluminium
opening: 100 mm
weight: 920 g



AZ 025
galvanized steel
opening: 80 mm
weight: 800 g

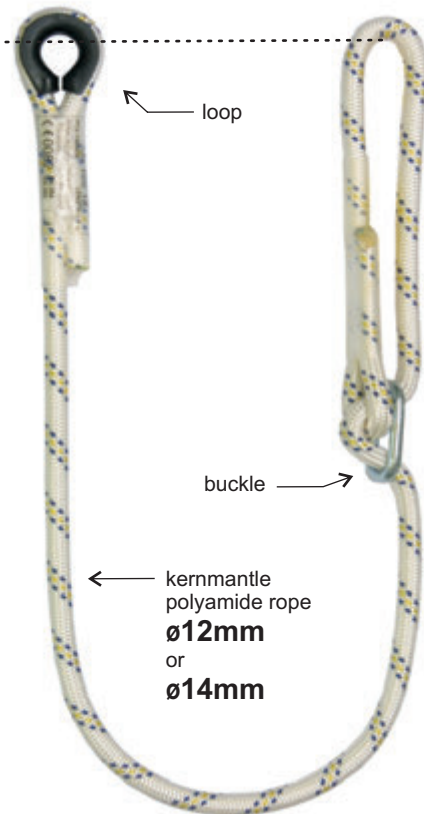

Can be used as:
- safety lanyard with energy absorber
- work positioning lanyard
Material: Polyamide

LB 100 universal adjustable safety lanyard \varnothing 12 mm

EN 354 EN 358



Ref.: LB 100 xx (xx - length)

Standards:

LB 100 10 - length 1,0m

LB 100 15 - length 1,5m

LB 100 20 - length 2,0m

OTHER LENGHTES
ON REQUEST



◀ ROPE
 \varnothing 12mm

LB 140 universal adjustable safety lanyard \varnothing 14 mm

EN 354 EN 358



Ref.: LB 140 xx (xx - length)

Standards:

LB 140 10 - length 1,0m

LB 140 15 - length 1,5m

LB 140 20 - length 2,0m

OTHER LENGHTES
ON REQUEST



◀ ROPE
 \varnothing 14mm

Safety lanyards

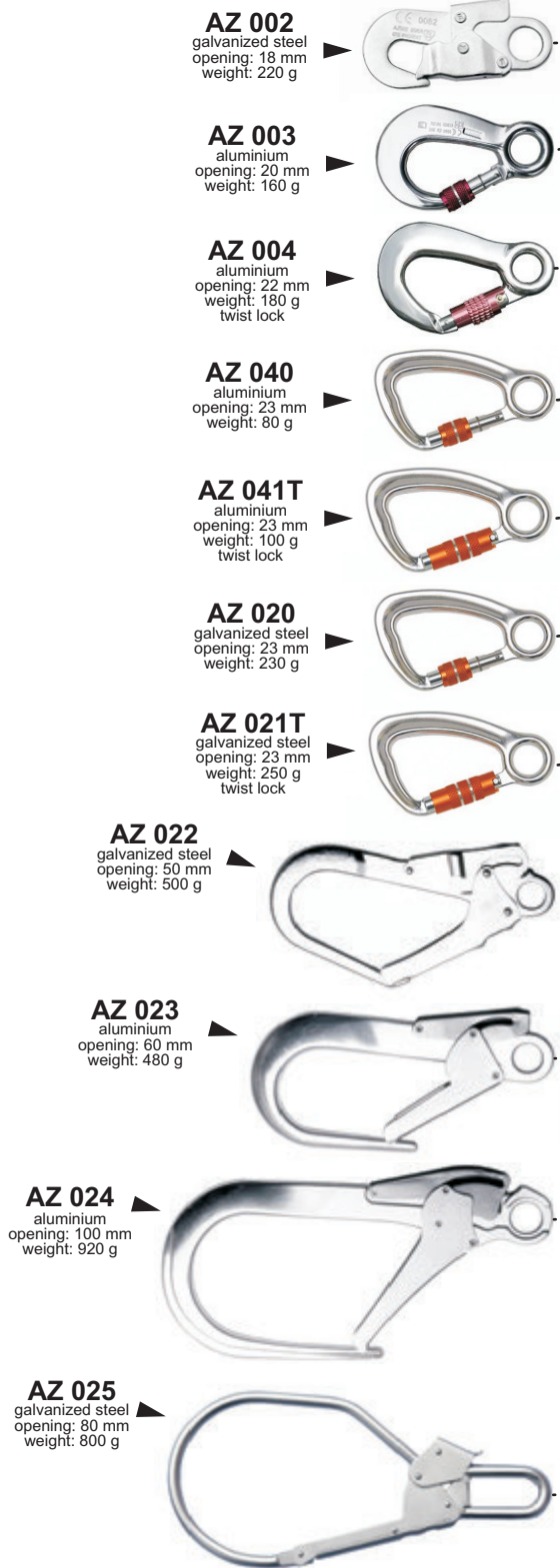

AZ 002
galvanized steel
opening: 18 mm
weight: 220 g

AZ 003
aluminium
opening: 20 mm
weight: 160 g

AZ 004
aluminium
opening: 22 mm
weight: 180 g
twist lock

AZ 040
aluminium
opening: 23 mm
weight: 80 g

AZ 041T
aluminium
opening: 23 mm
weight: 100 g
twist lock

AZ 020
galvanized steel
opening: 23 mm
weight: 230 g

AZ 021T
galvanized steel
opening: 23 mm
weight: 250 g
twist lock

AZ 022
galvanized steel
opening: 50 mm
weight: 500 g

AZ 023
aluminium
opening: 60 mm
weight: 480 g

AZ 024
aluminium
opening: 100 mm
weight: 920 g

AZ 025
galvanized steel
opening: 80 mm
weight: 800 g

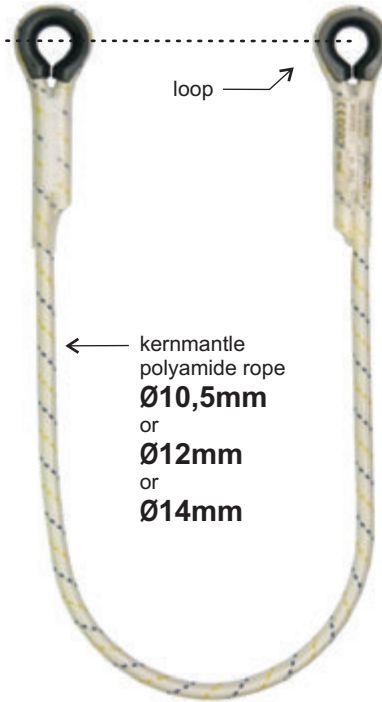

kernmantle
polyamide rope
Ø10,5mm
or
Ø12mm
or
Ø14mm

Can be used as:
- safety lanyard with energy absorber;
- work positioning lanyard;
Material: Polyamide;

LB 101 universal safety lanyard ø10,5mm

EN 354 EN 358



Ref.: LB 101 xx (xx - length)

Standards:

LB 101 10 - length 1,0m

LB 101 15 - length 1,5m

LB 101 20 - length 2,0m

OTHER LENGHTES ON REQUEST



◀ ROPE
Ø10,5mm

LB 121 universal safety lanyard ø12mm

EN 354 EN 358



Ref.: LB 121 xx (xx - length)

Standards:

LB 121 10 - length 1,0m

LB 121 15 - length 1,5m

LB 121 20 - length 2,0m

OTHER LENGHTES ON REQUEST



◀ ROPE
Ø12mm

LB 141 universal safety lanyard ø14mm

EN 354 EN 358



Ref.: LB 141 xx (xx - length)

Standards:

LB 141 10 - length 1,0m

LB 141 15 - length 1,5m

LB 141 20 - length 2,0m

OTHER LENGHTES ON REQUEST



◀ ROPE
Ø14mm

Safety lanyards

Aramid rope

AZ 011
galvanized steel
opening: 22 mm
weight: 180 g



AZ 002
galvanized steel
opening: 18 mm
weight: 220 g



AZ 003
aluminium
opening: 20 mm
weight: 160 g



AZ 004
aluminium
opening: 22 mm
weight: 180 g
twist lock



AZ 040
aluminium
opening: 23 mm
weight: 80 g



AZ 041T
aluminium
opening: 23 mm
weight: 100 g
twist lock



AZ 020
galvanized steel
opening: 23 mm
weight: 230 g



AZ 021T
galvanized steel
opening: 23 mm
weight: 250 g
twist lock



AZ 022
galvanized steel
opening: 50 mm
weight: 500 g



AZ 023
aluminium
opening: 60 mm
weight: 480 g



AZ 024
aluminium
opening: 100 mm
weight: 920 g



AZ 025
galvanized steel
opening: 80 mm
weight: 800 g

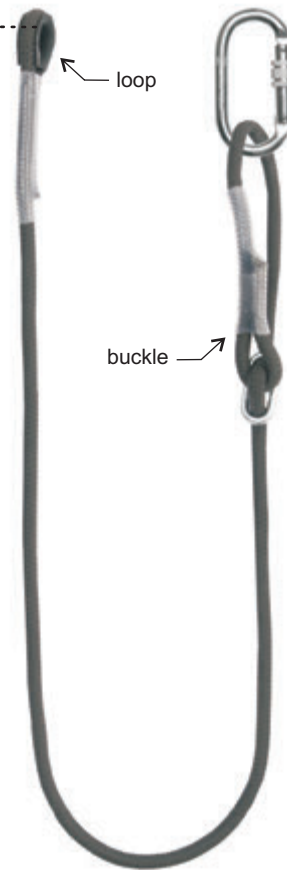

loop

buckle

ARAMID rope
with polyamide core
Ø 11 mm

LB 200 FLR universal adjustable safety lanyard

EN 354 EN 358



Ref.: LB 200 xx (xx - length)

Standards:

LB 200 10 - length 1,0 m

LB 200 15 - length 1,5 m

LB 200 20 - length 2,0 m

OTHER LENGHTES ON REQUEST

Can be used as:

- safety lanyard with energy absorber.

Material: Aramid rope with polyamide core

ATTENTION:

For hot works
like welding,
grinding, soldering
metal cutting.

The rope is protected
against sparks,
molten metal drops, etc.

EN 358 p.4.1.5
resistance to flame



Safety lanyards

Aramid rope

AZ 002
galvanized steel
opening: 18 mm
weight: 220 g



AZ 003
aluminium
opening: 20 mm
weight: 160 g



AZ 004
aluminium
opening: 22 mm
weight: 180 g
twist lock



AZ 040
aluminium
opening: 23 mm
weight: 80 g



AZ 041T
aluminium
opening: 23 mm
weight: 100 g
twist lock



AZ 020
galvanized steel
opening: 23 mm
weight: 230 g



AZ 021T
galvanized steel
opening: 23 mm
weight: 250 g
twist lock



AZ 022
galvanized steel
opening: 50 mm
weight: 500 g



AZ 023
aluminium
opening: 60 mm
weight: 480 g



AZ 024
aluminium
opening: 100 mm
weight: 920 g



AZ 025
galvanized steel
opening: 80 mm
weight: 800 g



loop

ARAMID rope
with polyamide core
Ø 11 mm

LB 201 FLR universal adjustable safety lanyard

EN 354 EN 358



Ref.: LB 201 xx (xx - length)

Standards:

LB 201 10 - length 1,0 m

LB 201 15 - length 1,5 m

LB 201 20 - length 2,0 m

OTHER LENGHTES ON REQUEST

Can be used as:

- safety lanyard with energy absorber.

Material: Aramid rope with polyamide core

ATTENTION:

For hot works
like welding,
grinding, soldering
metal cutting.

The rope is protected
against sparks,
molten metal drops, etc.

EN 358 p.4.1.5
resistance to flame



Safety lanyards

AZ 002
galvanized steel
opening: 18 mm
weight: 220 g



AZ 003
aluminium
opening: 20 mm
weight: 160 g



AZ 004
aluminium
opening: 22 mm
weight: 180 g
twist lock



AZ 040
aluminium
opening: 23 mm
weight: 80 g



AZ 041T
aluminium
opening: 23 mm
weight: 100 g
twist lock



AZ 020
galvanized steel
opening: 23 mm
weight: 230 g



AZ 021T
galvanized steel
opening: 23 mm
weight: 250 g
twist lock



AZ 022
galvanized steel
opening: 50 mm
weight: 500 g



AZ 023
aluminium
opening: 60 mm
weight: 480 g



AZ 024
aluminium
opening: 100 mm
weight: 920 g



AZ 025
galvanized steel
opening: 80 mm
weight: 800 g

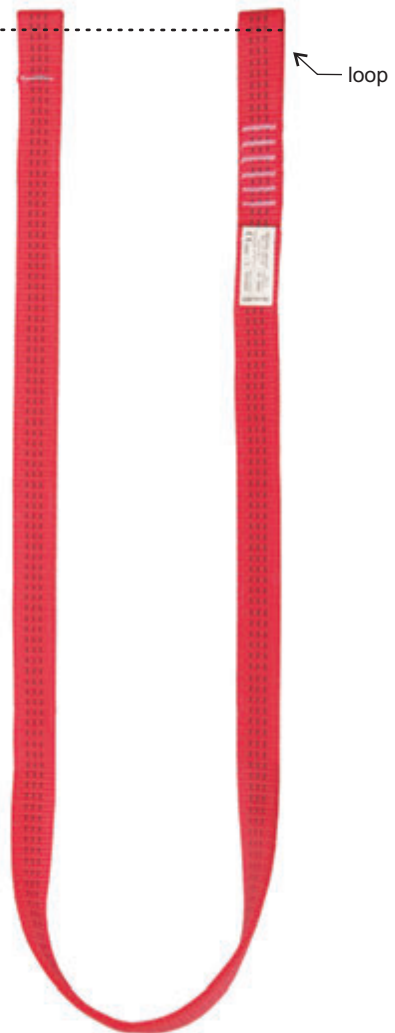

LT 101 universal safety lanyard

EN 354 EN 358



Ref.: LT 101 xx (xx - length)

Standards:

LT 101 08 - length 0,8m

LT 101 15 - length 1,5m

LT 101 20 - length 2,0m

OTHER LENGHTES ON REQUEST

Can be used as:

- safety lanyard with energy absorber;
- work positioning lanyard;

Material: Poliester;

Safety lanyards

- AZ 002**
galvanized steel
opening: 18 mm
weight: 220 g



- AZ 003**
aluminium
opening: 20 mm
weight: 160 g



- AZ 004**
aluminium
opening: 22 mm
weight: 180 g
twist lock



- AZ 040**
aluminium
opening: 23 mm
weight: 80 g



- AZ 041T**
aluminium
opening: 23 mm
weight: 100 g
twist lock



- AZ 020**
galvanized steel
opening: 23 mm
weight: 230 g



- AZ 021T**
galvanized steel
opening: 23 mm
weight: 250 g
twist lock

- AZ 022**
galvanized steel
opening: 50 mm
weight: 500 g

- AZ 023**
aluminium
opening: 60 mm
weight: 480 g

- AZ 024**
aluminium
opening: 100 mm
weight: 920 g

- AZ 025**
galvanized steel
opening: 80 mm
weight: 800 g





LE 101 elastic safety lanyard

EN 354



Ref.: LE 101 xx (xx - length)

Standards:

LE 101 10 - length 1,0m

LE 101 15 - length 1,5m

LE 101 20 - length 2,0m

OTHER LENGHTES ON REQUEST

Can be used as:

- safety lanyard with energy absorber.

Konstruktion: Double tubular webbing.

Safety lanyards

- AZ 002**
galvanized steel
opening: 18 mm
weight: 220 g



- AZ 003**
aluminium
opening: 20 mm
weight: 160 g



- AZ 004**
aluminium
opening: 22 mm
weight: 180 g
twist lock



- AZ 040**
aluminium
opening: 23 mm
weight: 80 g



- AZ 041T**
aluminium
opening: 23 mm
weight: 100 g
twist lock



- AZ 020**
galvanized steel
opening: 23 mm
weight: 230 g



- AZ 021T**
galvanized steel
opening: 23 mm
weight: 250 g
twist lock

- AZ 022**
galvanized steel
opening: 50 mm
weight: 500 g

- AZ 023**
aluminium
opening: 60 mm
weight: 480 g

- AZ 024**
aluminium
opening: 100 mm
weight: 920 g

- AZ 025**
galvanized steel
opening: 80 mm
weight: 800 g





LB 102 double safety lanyard

EN 354



Ref.: LB 102 xx xx (xx - length)

Standards:

LB 102 10 10 - length 2 x 1,0m

LB 102 15 15 - length 2 x 1,5m

LB 102 20 20 - length 2 x 2,0m

OTHER LENGHTES ON REQUEST

Can be used as:

- safety lanyard with energy absorber.

Fall arresters

on a flexible anchorage line

snap hooks for replace AZ 002

AZ 003
aluminium
opening: 20 mm
weight: 160 g

AZ 004
aluminium
opening: 22 mm
weight: 180 g
twist lock

AZ 040
aluminium
opening: 23 mm
weight: 80 g

AZ 041T
aluminium
opening: 23 mm
weight: 100 g
twist lock

AZ 020
galvanized steel
opening: 23 mm
weight: 230 g

AZ 021T
galvanized steel
opening: 23 mm
weight: 250 g
twist lock

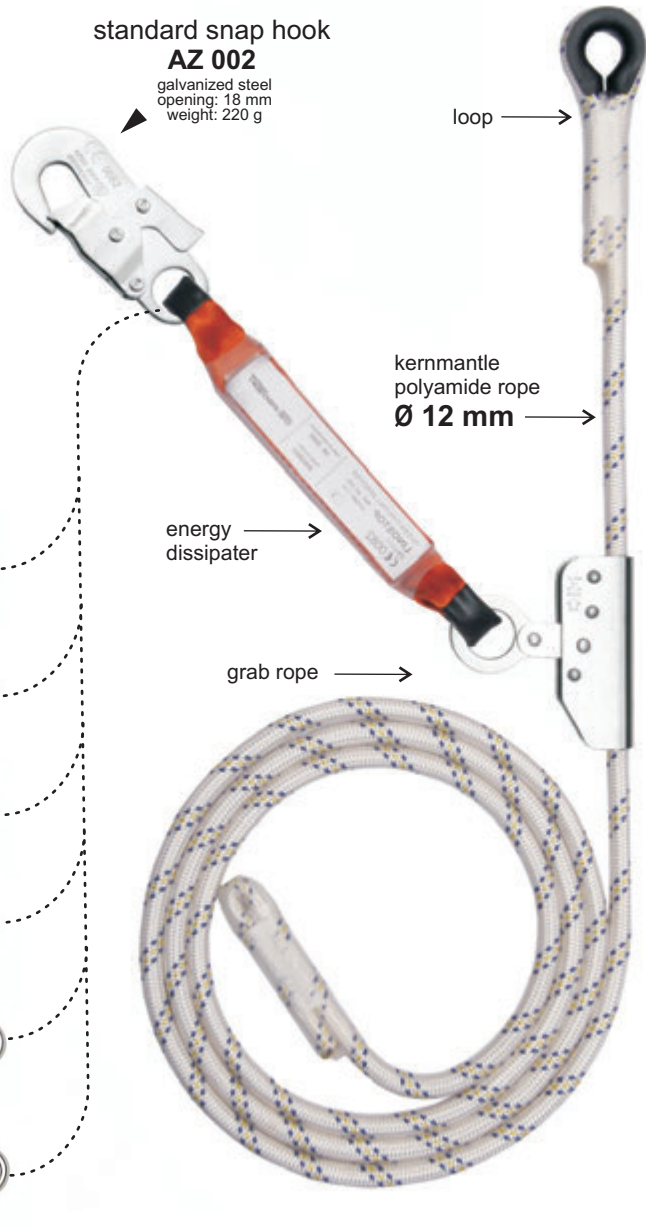

OTHER SNAP HOOKS ON REQUEST



LINOSTOP II

guided type fall arrester
on a flexible anchorage line

EN 353-2



Ref.: AC 060

Rope grab: stainless steel;
Energy dissipater: polyamide.

Standards:

- AC 060 + AZ 002 + working rope length 5m
- AC 060 + AZ 002 + working rope length 10m
- AC 060 + AZ 002 + working rope length 15m
- AC 060 + AZ 002 + working rope length 20m
- AC 060 + AZ 002 + working rope length 25m
- AC 060 + AZ 002 + working rope length 30m
- AC 060 + AZ 002 + working rope length 35m
- AC 060 + AZ 002 + working rope length 40m
- AC 060 + AZ 002 + working rope length 50m

Other lenghtes on request.

Fall arresters

on a flexible anchorage line

AC 010

guided type fall arrester
on a flexible anchorage line

EN 353-2



Ref.: AC 010

Rope grab: steel;
Dissipater energy: polyamide;

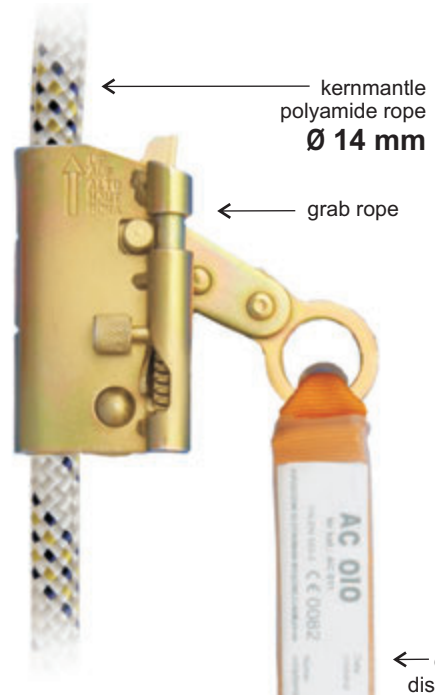

rope grab + AZ 002

snap hooks for replace AZ 002

AZ 003
aluminium
opening: 20 mm
weight: 160 g



AZ 004
aluminium
opening: 22 mm
weight: 180 g
twist lock



AZ 040
aluminium
opening: 23 mm
weight: 80 g



AZ 041T
aluminium
opening: 23 mm
weight: 100 g
twist lock



AZ 020
galvanized steel
opening: 23 mm
weight: 230 g



AZ 021T
galvanized steel
opening: 23 mm
weight: 250 g
twist lock



standard snap hook

AZ 002

galvanized steel
opening: 18 mm
weight: 220 g



AC 100 - Ø 14 mm ROPE FOR AC 010

EN 353-2



Standards:

Ref.: AC 100 10 - length 10 m

Ref.: AC 100 20 - length 20 m

Ref.: AC 100 30 - length 30 m

Ref.: AC 100 40 - length 40 m

Ref.: AC 100 50 - length 50 m

Other lengthes on request.

Ø 14 mm



OTHER SNAP HOOKS ON REQUEST



Fall arresters

on a flexible anchorage line

AC 040

guided type fall arrester
on a flexible anchorage line

EN 353-2



Ref.: AC 040

Rope grab: stainless steel

grab rope →

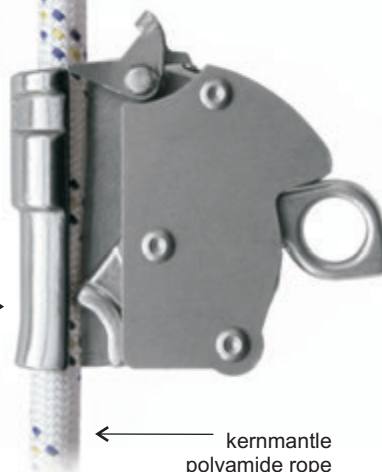

← kernmantle
polyamide rope
Ø 12 mm

AC 200 - Ø 12 mm ROPE FOR AC 040

EN 353-2



Standards:

Ref.: AC 200 10 - length 10 m

Ref.: AC 200 20 - length 20 m

Ref.: AC 200 30 - length 30 m

Ref.: AC 200 40 - length 40 m

Ref.: AC 200 50 - length 50 m

Other lengths on request.



Ø 12 mm

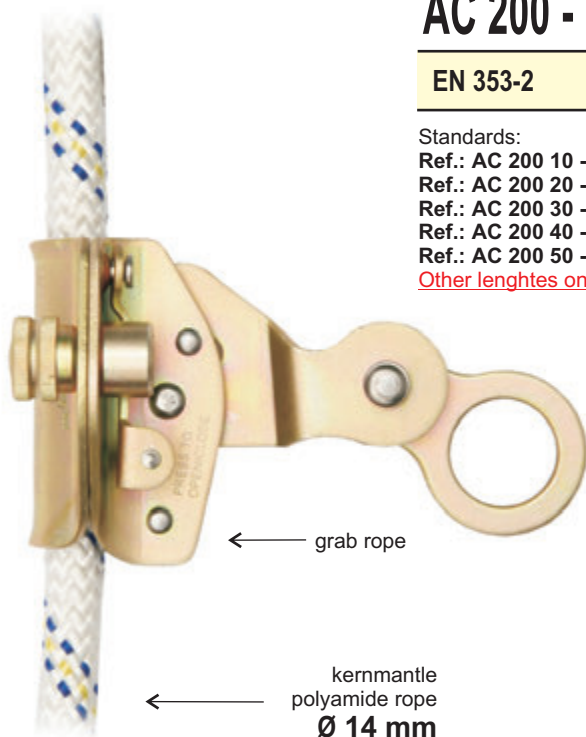

← grab rope

← kernmantle
polyamide rope
Ø 14 mm

AC 012

guided type fall arrester
on a flexible anchorage line

EN 353-2



Ref.: AC 012

Rope grab: galvanized steel

AC 100 - Ø 14 mm ROPE FOR AC 012

EN 353-2



Standards:

Ref.: AC 100 10 - length 10 m

Ref.: AC 100 20 - length 20 m

Ref.: AC 100 30 - length 30 m

Ref.: AC 100 40 - length 40 m

Ref.: AC 100 50 - length 50 m

Other lengths on request.



Ø 14 mm

Fall arresters

on a flexible anchorage line

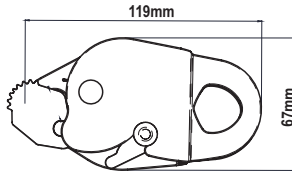
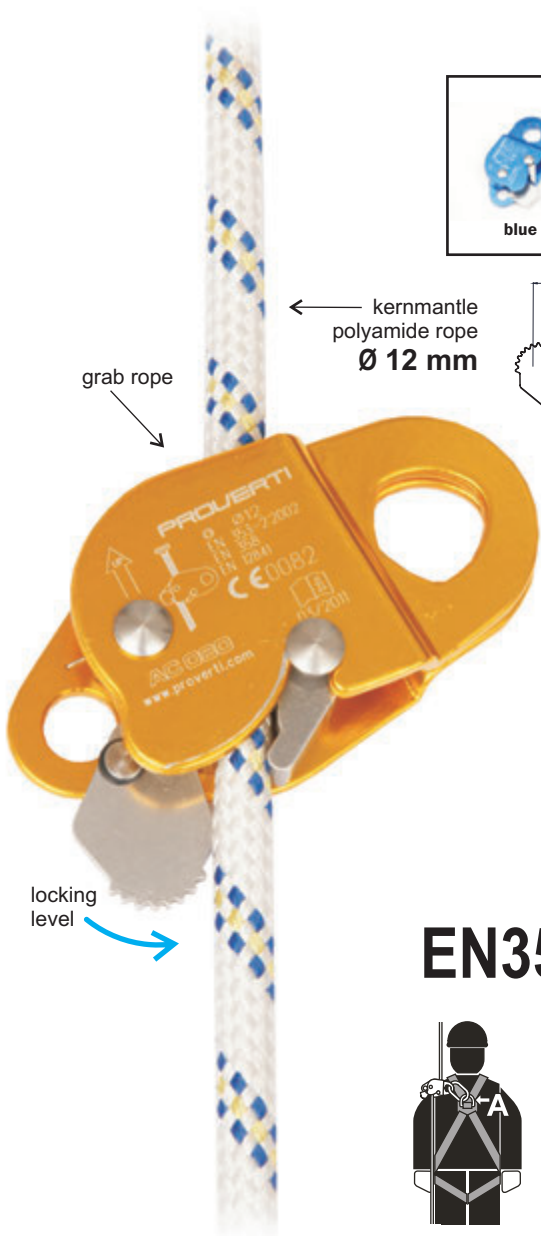

EN 12841



EN353-2

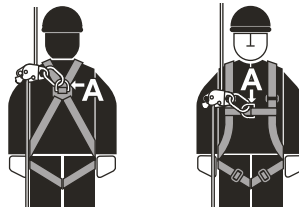

AC 080

guided type fall arrester
on a flexible anchorage line

EN 353-2, EN 358, EN 12841



Ref.: AC 080

Weight: 194 g

Material: forged alu alloy

AC 300

Ø 12 mm rope for AC 080

EN 353-2

Standards:

Ref.: AC 300 10 - length 10 m

Ref.: AC 300 20 - length 20 m

Ref.: AC 300 30 - length 30 m

Ref.: AC 300 40 - length 40 m

Ref.: AC 300 50 - length 50 m

Other lenghtes on request.



EN358

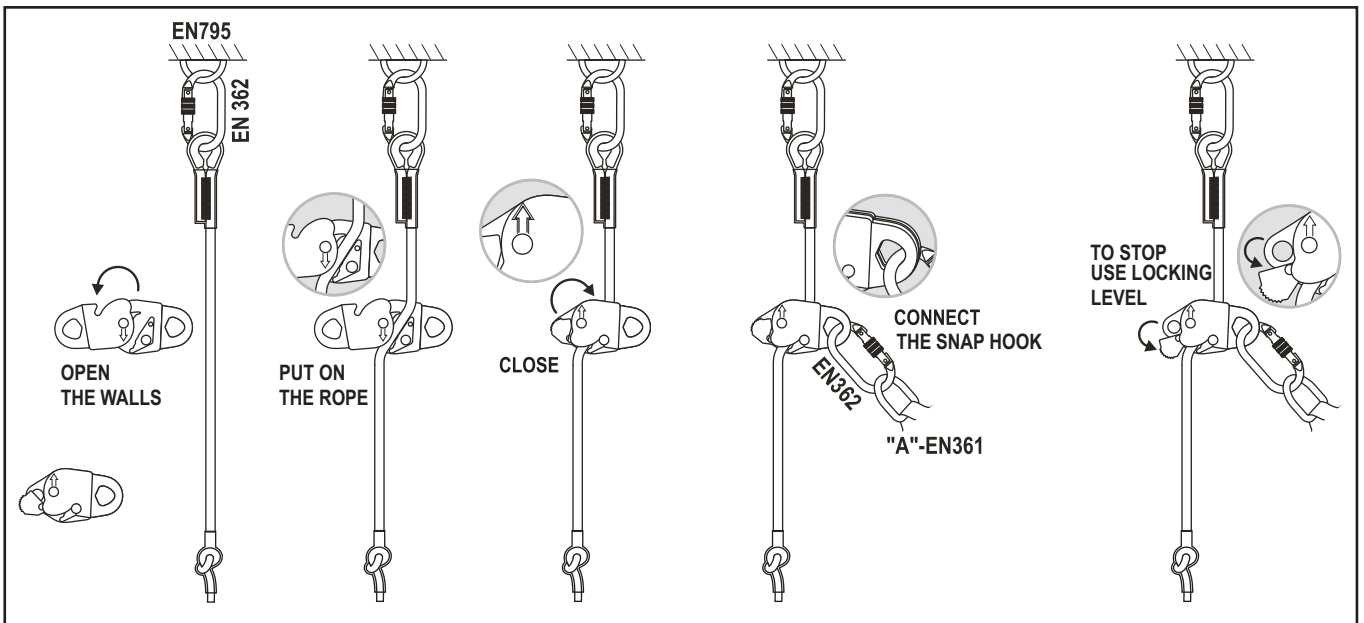
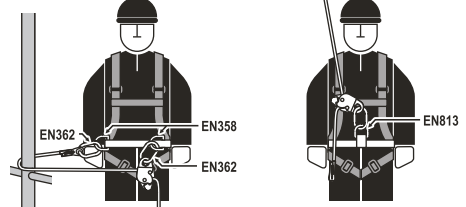

Fall arresters

on a flexible anchorage line

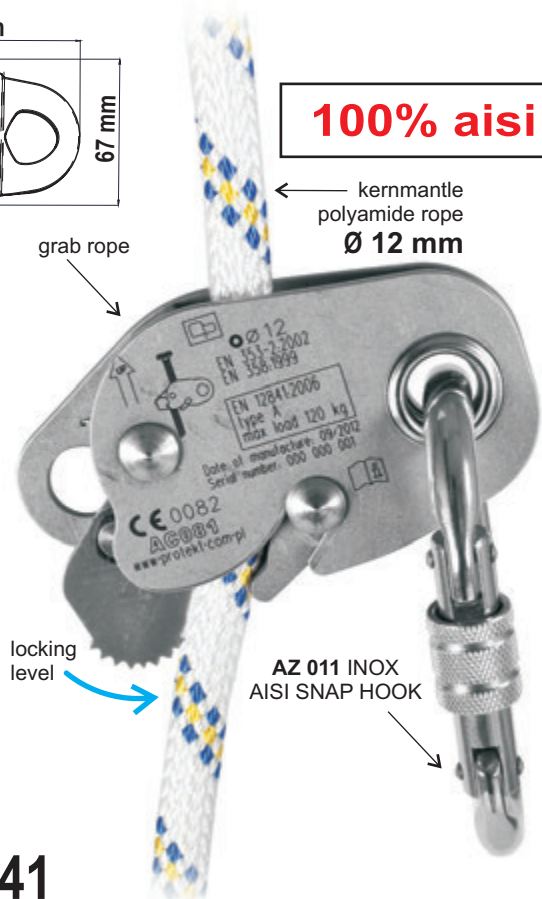
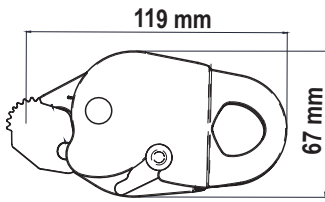

100% aisi

kernmantle polyamide rope
Ø 12 mm

grab rope

locking level

AZ 011 INOX
AISI SNAP HOOK

AC 081 NEW

guided type fall arrester
on a flexible anchorage line

EN 353-2, EN 358, EN 12841



Ref.: AC 081

Weight: 194 g

Material: stainless steel

AC 300

Ø 12 mm rope for AC 081

EN 353-2

Standards:

Ref.: AC 300 10 - length 10 m

Ref.: AC 300 20 - length 20 m

Ref.: AC 300 30 - length 30 m

Ref.: AC 300 40 - length 40 m

Ref.: AC 300 50 - length 50 m

Other lenghtes on request.



EN 12841



EN353-2

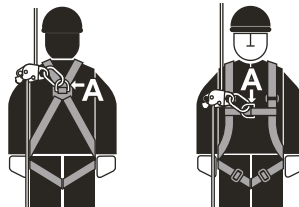

EN358

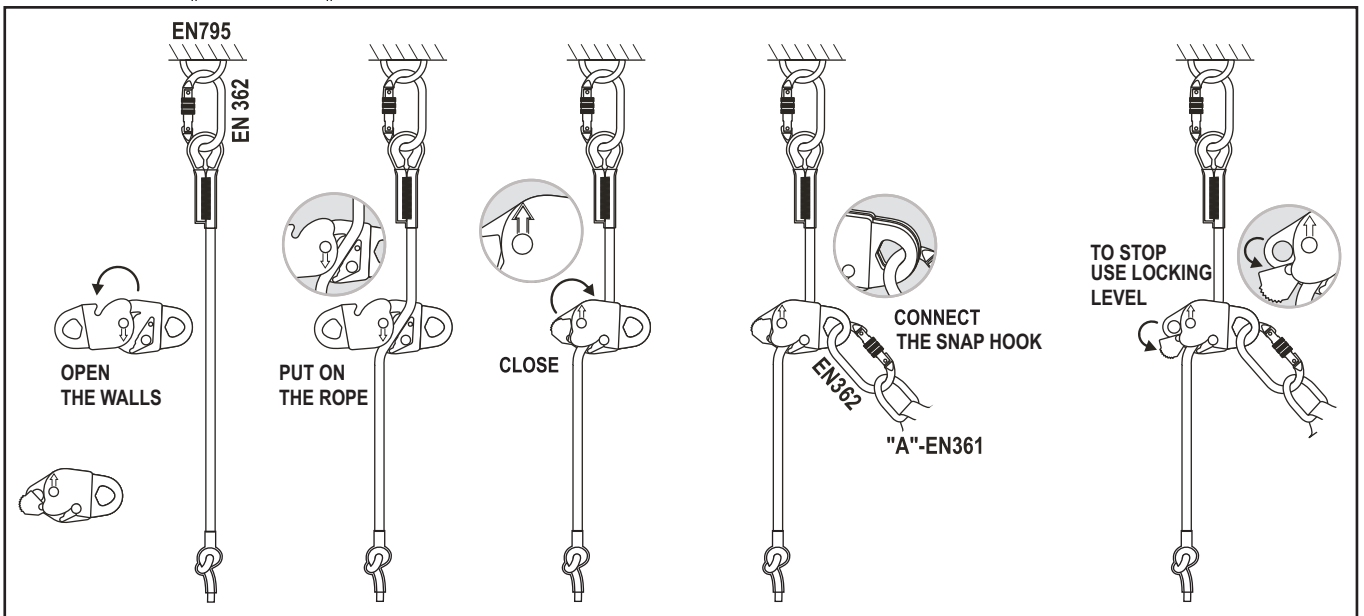
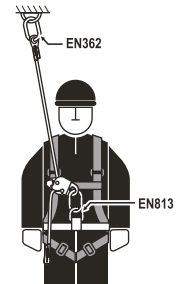
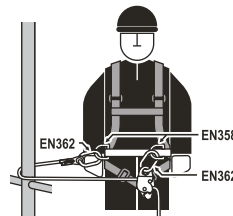

Work positioning

AZ 002
galvanized steel
opening: 18 mm
weight: 220 g

AZ 003
aluminium
opening: 20 mm
weight: 160 g

AZ 004
aluminium
opening: 22 mm
weight: 180 g
twist lock

AZ 040
aluminium
opening: 23 mm
weight: 80 g

AZ 041T
aluminium
opening: 23 mm
weight: 100 g
twist lock

AZ 020
galvanized steel
opening: 23 mm
weight: 230 g

AZ 021T
galvanized steel
opening: 23 mm
weight: 250 g
twist lock

AZ 030
aluminium,
galvanized steel
opening: 23 mm
weight: 200 g

AZ 031T
aluminium,
galvanized steel
opening: 23 mm
weight: 200 g
twist lock

AZ 050
galvanized steel
opening: 23 mm
weight: 360 g

AZ 051T
galvanized steel
opening: 23 mm
weight: 360 g

NEW!
AZ 002AS
aluminium,
opening: 24 mm
weight: 215 g

AZ 060
galvanized steel
opening: 21 mm
weight: 380 g

← free ending of the rope

AZ 011
galvanized steel
opening: 18 mm
weight: 220 g

adjuster of the rope length
nickel-plated steel

← kernmantle polyester rope
Ø 12 mm

← protecting tube

PROT 11
WORK POSITIONING DEVICE

EN 358

Ref.: AF 101 xx (xx - length)

Standards:
AF 101 02 - length 2 m
AF 101 03 - length 3 m
AF 101 04 - length 4 m
AF 101 05 - length 5 m
AF 101 10 - length 10 m
AF 101 15 - length 15 m
AF 101 20 - length 20 m
Other lenghtes on request.

Work positioning

AZ 002
galvanized steel
opening: 18 mm
weight: 220 g

AZ 011
galvanized steel
opening: 18 mm
weight: 220 g

AZ 003
aluminium
opening: 20 mm
weight: 160 g

AZ 004
aluminium
opening: 22 mm
weight: 180 g
twist lock

AZ 040
aluminium
opening: 23 mm
weight: 80 g

AZ 041T
aluminium
opening: 23 mm
weight: 100 g
twist lock

AZ 020
galvanized steel
opening: 23 mm
weight: 230 g

AZ 021T
galvanized steel
opening: 23 mm
weight: 250 g
twist lock

AZ 030
aluminium,
galvanized steel
opening: 23 mm
weight: 200 g

AZ 031T
aluminium,
galvanized steel
opening: 23 mm
weight: 200 g
twist lock

AZ 050
galvanized steel
opening: 23 mm
weight: 360 g

AZ 051T
galvanized steel
opening: 23 mm
weight: 360 g

NEW!
AZ 002AS
aluminium,
opening: 24 mm
weight: 215 g

AZ 060
galvanized steel
opening: 21 mm
weight: 380 g

adjuster
of the
rope length
stainless steel

polyester
kermantle rope
Ø 14 mm

protecting
tube

PROT 2
WORK POSITIONING DEVICE

EN 358

CE

Ref.: AF 201 xx (xx - length)

Standards:
AF 201 02 - length 2 m
AF 201 03 - length 3 m
AF 201 04 - length 4 m
AF 201 05 - length 5 m
AF 201 10 - length 10 m
AF 201 15 - length 15 m
AF 201 20 - length 20 m
Other lenghtes on request.

Work positioning

AZ 002
galvanized steel
opening: 18 mm
weight: 220 g

AZ 003
aluminium
opening: 20 mm
weight: 160 g

AZ 004
aluminium
opening: 22 mm
weight: 180 g
twist lock

AZ 040
aluminium
opening: 23 mm
weight: 80 g

AZ 041T
aluminium
opening: 23 mm
weight: 100 g
twist lock

AZ 020
galvanized steel
opening: 23 mm
weight: 230 g

AZ 021T
galvanized steel
opening: 23 mm
weight: 250 g
twist lock

AZ 030
aluminium,
galvanized steel
opening: 23 mm
weight: 200 g

AZ 031T
aluminium,
galvanized steel
opening: 23 mm
weight: 200 g
twist lock

AZ 050
galvanized steel
opening: 23 mm
weight: 360 g

AZ 051T
galvanized steel
opening: 23 mm
weight: 360 g

NEW!
AZ 002AS
aluminium,
opening: 24 mm
weight: 215 g

AZ 060
galvanized steel
opening: 21 mm
weight: 380 g

free ending of the rope

adjuster of the rope length
light alloys

kernmantle polyester rope
Ø 14 mm

protecting tube

PROT 3
WORK POSITIONING DEVICE

EN 358

Ref.: AF 130 xx (xx - length)

Standards:
AF 130 02 - length 2 m
AF 130 03 - length 3 m
AF 130 04 - length 4 m
AF 130 05 - length 5 m
AF 130 10 - length 10 m
AF 130 15 - length 15 m
AF 130 20 - length 20 m
Other lenghtes on request.

Work positioning

AZ 002
galvanized steel
opening: 18 mm
weight: 220 g

AZ 003
aluminium
opening: 20 mm
weight: 160 g

AZ 004
aluminium
opening: 22 mm
weight: 180 g
twist lock

AZ 040
aluminium
opening: 23 mm
weight: 80 g

AZ 041T
aluminium
opening: 23 mm
weight: 100 g
twist lock

AZ 020
galvanized steel
opening: 23 mm
weight: 230 g

AZ 021T
galvanized steel
opening: 23 mm
weight: 250 g
twist lock

AZ 030
aluminium,
galvanized steel
opening: 23 mm
weight: 200 g

AZ 031T
aluminium,
galvanized steel
opening: 23 mm
weight: 200 g
twist lock

AZ 050
galvanized steel
opening: 23 mm
weight: 360 g

AZ 051T
galvanized steel
opening: 23 mm
weight: 360 g

NEW!
AZ 002AS
aluminium,
opening: 24 mm
weight: 215 g

AZ 060
galvanized steel
opening: 21 mm
weight: 380 g

AZ 011
galvanized steel
opening: 18 mm
weight: 220 g

adjuster of the rope length
steel zinc plated

steel cable covered by polyester
Ø 16 mm











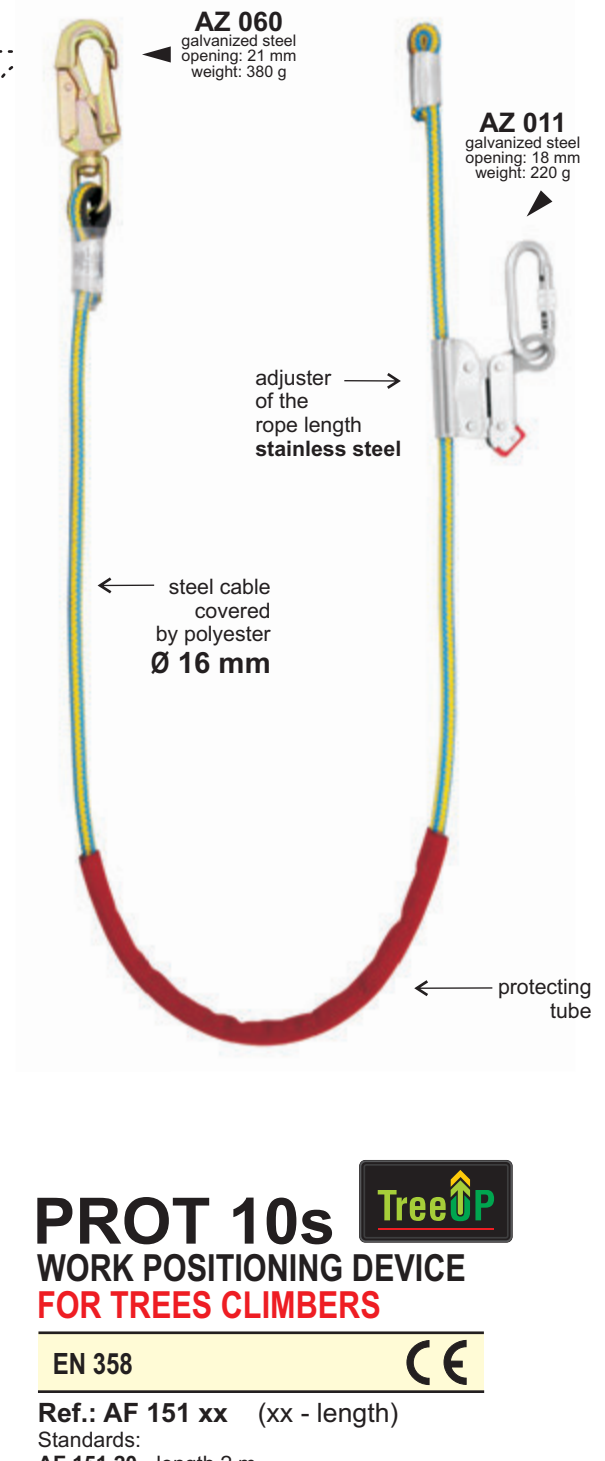

protecting tube

PROT 10 
**WORK POSITIONING DEVICE
FOR TREES CLIMBERS**

EN 358 

Ref.: AF 150 xx (xx - length)
Standards:
AF 150 20 - length 2 m
AF 150 30 - length 3 m
AF 150 40 - length 4 m
AF 150 50 - length 5 m
Other lenghtes on request.

Work positioning

<p>AZ 002 galvanized steel opening: 18 mm weight: 220 g</p>		 <p>AZ 060 galvanized steel opening: 21 mm weight: 380 g</p> <p>AZ 011 galvanized steel opening: 18 mm weight: 220 g</p> <p>adjuster of the rope length stainless steel</p> <p>steel cable covered by polyester Ø 16 mm</p> <p>protecting tube</p>
<p>AZ 003 aluminium opening: 20 mm weight: 160 g</p>		
<p>AZ 004 aluminium opening: 22 mm weight: 180 g twist lock</p>		
<p>AZ 040 aluminium opening: 23 mm weight: 80 g</p>		
<p>AZ 041T aluminium opening: 23 mm weight: 100 g twist lock</p>		
<p>AZ 020 galvanized steel opening: 23 mm weight: 230 g</p>		
<p>AZ 021T galvanized steel opening: 23 mm weight: 250 g twist lock</p>		
<p>AZ 030 aluminium, galvanized steel opening: 23 mm weight: 200 g</p>		
<p>AZ 031T aluminium, galvanized steel opening: 23 mm weight: 200 g twist lock</p>		
<p>AZ 050 galvanized steel opening: 23 mm weight: 360 g</p>		
<p>AZ 051T galvanized steel opening: 23 mm weight: 360 g</p>		
<p>NEW! AZ 002AS aluminium, opening: 24 mm weight: 215 g</p>		

PROT 10s

WORK POSITIONING DEVICE FOR TREES CLIMBERS

EN 358 

Ref.: AF 151 xx (xx - length)

- Standards:
 AF 151 20 - length 2 m
 AF 151 30 - length 3 m
 AF 151 40 - length 4 m
 AF 151 50 - length 5 m

Other lenghtes on request.

Work positioning

AZ 002
galvanized steel
opening: 18 mm
weight: 220 g

AZ 003
aluminium
opening: 20 mm
weight: 160 g

AZ 004
aluminium
opening: 22 mm
weight: 180 g
twist lock

AZ 040
aluminium
opening: 23 mm
weight: 80 g

AZ 041T
aluminium
opening: 23 mm
weight: 100 g
twist lock

AZ 020
galvanized steel
opening: 23 mm
weight: 230 g

AZ 021T
galvanized steel
opening: 23 mm
weight: 250 g
twist lock

AZ 030
aluminium,
galvanized steel
opening: 23 mm
weight: 200 g

AZ 031T
aluminium,
galvanized steel
opening: 23 mm
weight: 200 g
twist lock

AZ 050
galvanized steel
opening: 23 mm
weight: 360 g

AZ 051T
galvanized steel
opening: 23 mm
weight: 360 g

NEW!
AZ 002AS
aluminium,
opening: 24 mm
weight: 215 g

AZ 060
galvanized steel
opening: 21 mm
weight: 380 g

AZ 011
galvanized steel
opening: 18 mm
weight: 220 g

adjuster of the rope length
light alloys

steel cable covered by polyester
Ø 16 mm

protecting tube

PROT 30 
**WORK POSITIONING DEVICE
FOR TREES CLIMBERS**

EN 358 

Ref.: AF 160 xx (xx - length)
Standards:
AF 160 20 - length 2 m
AF 160 30 - length 3 m
AF 160 40 - length 4 m
AF 160 50 - length 5 m
Other lenghtes on request.

Work positioning

AZ 002
galvanized steel
opening: 18 mm
weight: 220 g

AZ 003
aluminium
opening: 20 mm
weight: 160 g

AZ 004
aluminium
opening: 22 mm
weight: 180 g
twist lock

AZ 040
aluminium
opening: 23 mm
weight: 80 g

AZ 041T
aluminium
opening: 23 mm
weight: 100 g
twist lock

AZ 020
galvanized steel
opening: 23 mm
weight: 230 g

AZ 021T
galvanized steel
opening: 23 mm
weight: 250 g
twist lock

AZ 030
aluminium,
galvanized steel
opening: 23 mm
weight: 200 g

AZ 031T
aluminium,
galvanized steel
opening: 23 mm
weight: 200 g
twist lock

AZ 050
galvanized steel
opening: 23 mm
weight: 360 g

AZ 051T
galvanized steel
opening: 23 mm
weight: 360 g

NEW!
AZ 002AS
aluminium,
opening: 24 mm
weight: 215 g

AZ 060
galvanized steel
opening: 21 mm
weight: 380 g

loop

adjuster of the rope length
chrome plated steel

AZ 011
galvanized steel
opening: 18 mm
weight: 220 g

steel cable covered by polyester
Ø 11 mm

protecting tube

PROT 40 
**WORK POSITIONING DEVICE
FOR TREES CLIMBERS**

EN 358 

Ref.: AF 140 xx (xx - length)
Standards:
AF 140 20 - length 2 m
AF 140 30 - length 3 m
AF 140 40 - length 4 m
AF 140 50 - length 5 m
Other lenghtes on request.

Work positioning

AZ 002
galvanized steel
opening: 18 mm
weight: 220 g



AZ 003
aluminium
opening: 20 mm
weight: 160 g



AZ 004
aluminium
opening: 22 mm
weight: 180 g
twist lock



AZ 040
aluminium
opening: 23 mm
weight: 80 g



AZ 041T
aluminium
opening: 23 mm
weight: 100 g
twist lock



AZ 020
galvanized steel
opening: 23 mm
weight: 230 g



AZ 021T
galvanized steel
opening: 23 mm
weight: 250 g
twist lock



AZ 030
aluminium,
galvanized steel
opening: 23 mm
weight: 200 g



AZ 031T
aluminium,
galvanized steel
opening: 23 mm
weight: 200 g
twist lock



AZ 050
galvanized steel
opening: 23 mm
weight: 360 g



AZ 051T
galvanized steel
opening: 23 mm
weight: 360 g



NEW!
AZ 002AS
aluminium,
opening: 24 mm
weight: 215 g



AZ 060
galvanized steel
opening: 21 mm
weight: 380 g

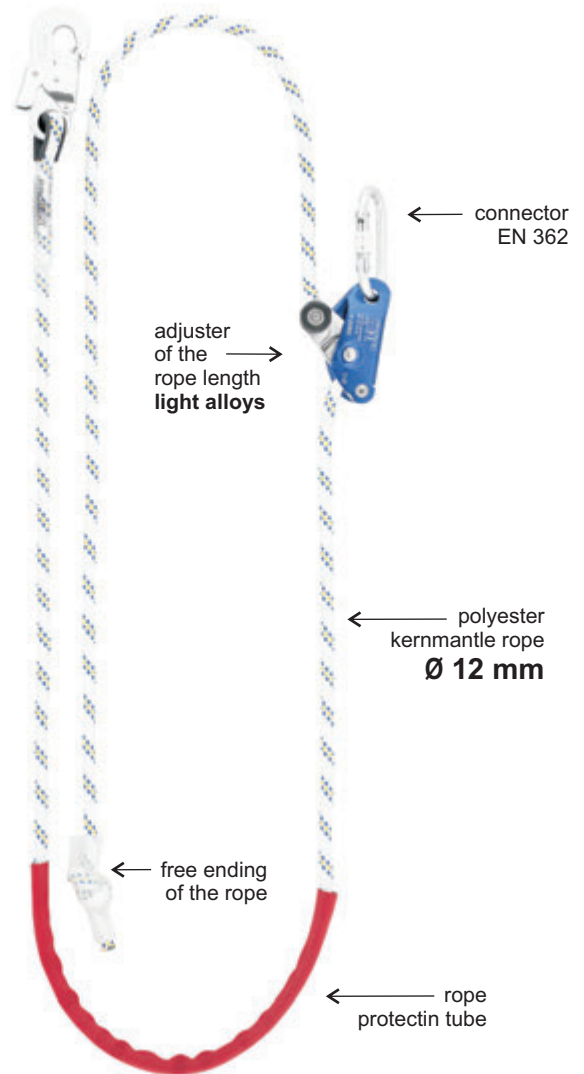

PROT 4 NEW! WORK POSITIONING DEVICE

EN 358



Ref.: AF 104 xx (xx - length)











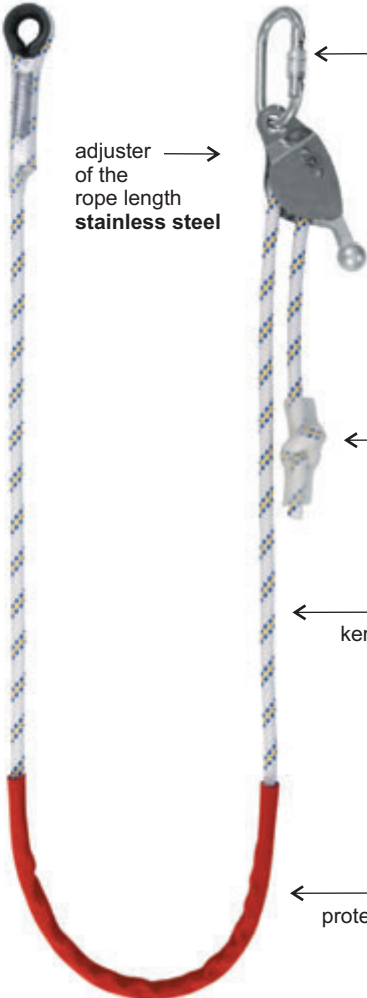

Material: stainless steel
and polyester kernmantle rope

Standards:

- AF 104 20 - length 2 m
- AF 104 25 - length 2,5 m
- AF 104 30 - length 3 m
- AF 104 40 - length 4 m
- AF 104 50 - length 5 m
- AF 104 100 - length 10 m
- AF 104 200 - length 20 m

Other lenghtes on request.

Work positioning

<p>AZ 002 galvanized steel opening: 18 mm weight: 220 g</p>		 <p>adjuster → of the rope length stainless steel</p> <p>← connector EN 362</p> <p>← free ending of the rope</p> <p>← polyester kernmantle rope Ø 12 mm</p> <p>← rope protectin tube</p>
<p>AZ 003 aluminium opening: 20 mm weight: 160 g</p>		
<p>AZ 004 aluminium opening: 22 mm weight: 180 g twist lock</p>		
<p>AZ 040 aluminium opening: 23 mm weight: 80 g</p>		
<p>AZ 041T aluminium opening: 23 mm weight: 100 g twist lock</p>		
<p>AZ 020 galvanized steel opening: 23 mm weight: 230 g</p>		
<p>AZ 021T galvanized steel opening: 23 mm weight: 250 g twist lock</p>		
<p>AZ 030 aluminium, galvanized steel opening: 23 mm weight: 200 g</p>		
<p>AZ 031T aluminium, galvanized steel opening: 23 mm weight: 200 g twist lock</p>		
<p>AZ 050 galvanized steel opening: 23 mm weight: 360 g</p>		
<p>AZ 051T galvanized steel opening: 23 mm weight: 360 g</p>		
<p>NEW! AZ 002AS aluminium, opening: 24 mm weight: 215 g</p>		
<p>AZ 060 galvanized steel opening: 21 mm weight: 380 g</p>		

PROT 22

WORK POSITIONING DEVICE

EN 358 CE

Ref.: AF 222 xx (xx - length)
Material: stainless steel
and polyester kernmantle rope

Standards:
 AF 222 20 - length 2 m
 AF 222 25 - length 2,5 m
 AF 222 30 - length 3 m
 AF 222 40 - length 4 m
 AF 222 50 - length 5 m
 AF 222 100 - length 10 m
 AF 222 200 - length 20 m
Other lenghtes on request.

Work positioning

AZ 002
galvanized steel
opening: 18 mm
weight: 220 g

AZ 003
aluminium
opening: 20 mm
weight: 160 g

AZ 004
aluminium
opening: 22 mm
weight: 180 g
twist lock

AZ 040
aluminium
opening: 23 mm
weight: 80 g

AZ 041T
aluminium
opening: 23 mm
weight: 100 g
twist lock

AZ 020
galvanized steel
opening: 23 mm
weight: 230 g

AZ 021T
galvanized steel
opening: 23 mm
weight: 250 g
twist lock

AZ 030
aluminium,
galvanized steel
opening: 23 mm
weight: 200 g

AZ 031T
aluminium,
galvanized steel
opening: 23 mm
weight: 200 g
twist lock

AZ 050
galvanized steel
opening: 23 mm
weight: 360 g

AZ 051T
galvanized steel
opening: 23 mm
weight: 360 g

NEW!
AZ 002AS
aluminium,
opening: 24 mm
weight: 215 g

AZ 060
galvanized steel
opening: 21 mm
weight: 380 g

← polyester kernmantle rope Ø 16 mm

adjuster of the rope length
light alloys →

← rope protectin tube

PROT 6 NEW
WORK POSITIONING DEVICE

EN 358 **CE**

Ref.: AF 106 xx (xx - length)
Material: aluminium and polyamide braided rope

Standards:
AF 106 20 - length 2 m
AF 106 25 - length 2,5 m
AF 106 30 - length 3 m
AF 106 40 - length 4 m
AF 106 50 - length 5 m
AF 106 100 - length 10 m
AF 106 200 - length 20 m
Other lenghtes on request.

Work positioning

AZ 002
galvanized steel
opening: 18 mm
weight: 220 g

AZ 003
aluminium
opening: 20 mm
weight: 160 g

AZ 004
aluminium
opening: 22 mm
weight: 180 g
twist lock

AZ 040
aluminium
opening: 23 mm
weight: 80 g

AZ 041T
aluminium
opening: 23 mm
weight: 100 g
twist lock

AZ 020
galvanized steel
opening: 23 mm
weight: 230 g

AZ 021T
galvanized steel
opening: 23 mm
weight: 250 g
twist lock

AZ 030
aluminium,
galvanized steel
opening: 23 mm
weight: 200 g

AZ 031T
aluminium,
galvanized steel
opening: 23 mm
weight: 200 g
twist lock

AZ 050
galvanized steel
opening: 23 mm
weight: 360 g

AZ 051T
galvanized steel
opening: 23 mm
weight: 360 g

NEW!
AZ 002AS
aluminium,
opening: 24 mm
weight: 215 g

AZ 060
galvanized steel
opening: 21 mm
weight: 380 g

← polypropylene
braided steel rope
Ø 16 mm

adjuster →
of the
rope length
stainless steel

← rope
protectin tube











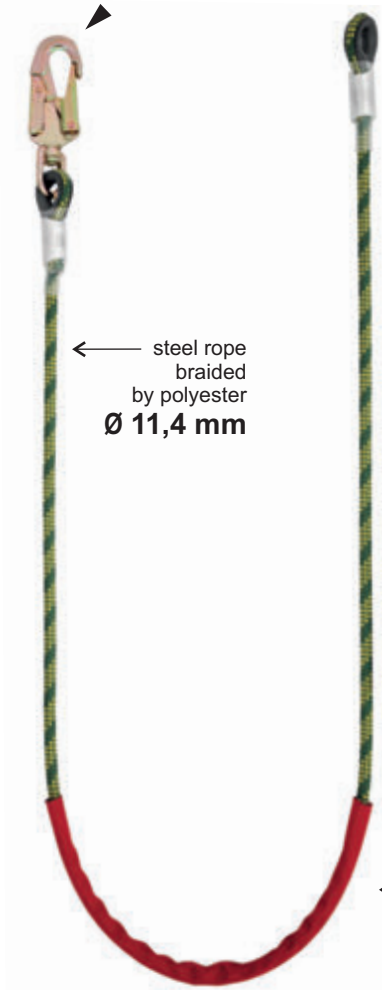

PROT 70 NEW
WORK POSITIONING DEVICE

EN 358 **CE**

Ref.: AF 170 xx (xx - length)
Material: stainless steel
and polypropylene braided steel rope

Standards:
AF 170 20 - length 2 m
AF 170 25 - length 2,5 m
AF 170 30 - length 3 m
AF 170 40 - length 4 m
AF 170 50 - length 5 m
AF 170 100 - length 10 m
AF 170 200 - length 20 m
Other lenghtes on request.

Work positioning

<p>AZ 002 galvanized steel opening: 18 mm weight: 220 g</p>		 <p>AZ 060 galvanized steel opening: 21 mm weight: 380 g</p> <p>← limiter of rope with a thimble</p> <p>← steel rope braided by polyester Ø 11,4 mm</p> <p>← rope protectin tube</p>
<p>AZ 003 aluminium opening: 20 mm weight: 160 g</p>		
<p>AZ 004 aluminium opening: 22 mm weight: 180 g twist lock</p>		
<p>AZ 040 aluminium opening: 23 mm weight: 80 g</p>		
<p>AZ 041T aluminium opening: 23 mm weight: 100 g twist lock</p>		
<p>AZ 020 galvanized steel opening: 23 mm weight: 230 g</p>		
<p>AZ 021T galvanized steel opening: 23 mm weight: 250 g twist lock</p>		
<p>AZ 030 aluminium, galvanized steel opening: 23 mm weight: 200 g</p>		
<p>AZ 031T aluminium, galvanized steel opening: 23 mm weight: 200 g twist lock</p>		
<p>AZ 050 galvanized steel opening: 23 mm weight: 360 g</p>		
<p>AZ 051T galvanized steel opening: 23 mm weight: 360 g</p>		
<p>NEW! AZ 002AS aluminium, opening: 24 mm weight: 215 g</p>		

TU 011 **NEW**

WORK POSITIONING DEVICE FOR TREES CLIMBERS

EN 358



Ref.: TU 011 xx (xx - length)
Material: polyester braided steel rope 11,4 mm

Standards:
TU 011 200 - length 2 m
TU 011 300 - length 3 m
TU 011 400 - length 4 m
TU 011 500 - length 5 m

Other lenghtes on request.

Work positioning

- AZ 002**
galvanized steel
opening: 18 mm
weight: 220 g



- AZ 003**
aluminium
opening: 20 mm
weight: 160 g



- AZ 004**
aluminium
opening: 22 mm
weight: 180 g
twist lock



- AZ 040**
aluminium
opening: 23 mm
weight: 80 g



- AZ 041T**
aluminium
opening: 23 mm
weight: 100 g
twist lock



- AZ 020**
galvanized steel
opening: 23 mm
weight: 230 g



- AZ 021T**
galvanized steel
opening: 23 mm
weight: 250 g
twist lock

- AZ 022**
galvanized steel
opening: 50 mm
weight: 500 g

- AZ 023**
aluminium
opening: 60 mm
weight: 480 g

- AZ 024**
aluminium
opening: 100 mm
weight: 920 g

- AZ 025**
galvanized steel
opening: 80 mm
weight: 800 g





AF 500 WORK POSITIONING LANYARD

EN 358



Ref.: AF 500

AF 500 16 - length 1,6m

AF 500 20 - length 2,0m

OTHER LENGHTES ON REQUEST

Material: Poliester

Work positioning

AZ 600 WORK POSITIONING LANYARD

EN 795 type B



Ref.: AZ 600

AZ 600 002 - length 1,5m

AZ 600 003 - length 3,0m

AZ 600 006 - length 6,0m

Material: textile webbing

Width of tape: 40mm

Length: 2 - 6m

Static strength: 22kN

Portable anchoring point. One end is terminated with a metal ring.

The webbing is provided with an adjustable buckle.

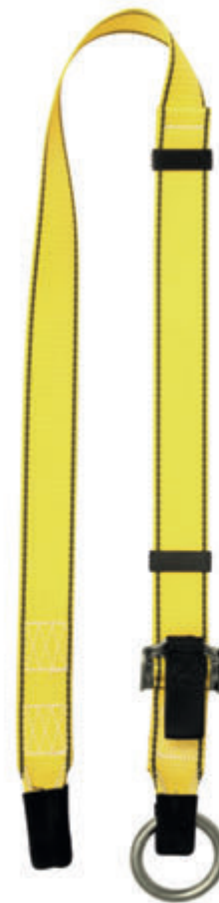

TU 900 CLIMBING SAVER

EN 795 class B



Ref.: TU 900

Length: 40, 60, 80, 100, 120, 140, 170 cm
(available also in other lengths)

Static strength: 15 kN

Weight for 1 m: 280g

Work positioning lanyard TU 900 is terminated with rings of different diameters. Rigid flat tape reduces twisting. TU 900 ensures protection of tree branches and facilitates moving the cable at work positioning height.

Work positioning

- AZ 002**
galvanized steel
opening: 18 mm
weight: 220 g
- AZ 003**
aluminium
opening: 20 mm
weight: 160 g
- AZ 004**
aluminium
opening: 22 mm
weight: 180 g
twist lock
- AZ 040**
aluminium
opening: 23 mm
weight: 80 g
- AZ 041T**
aluminium
opening: 23 mm
weight: 100 g
twist lock
- AZ 020**
galvanized steel
opening: 23 mm
weight: 230 g
- AZ 021T**
galvanized steel
opening: 23 mm
weight: 250 g
twist lock
- AZ 022**
galvanized steel
opening: 50 mm
weight: 500 g
- AZ 023**
aluminium
opening: 60 mm
weight: 480 g
- AZ 024**
aluminium
opening: 100 mm
weight: 920 g
- AZ 025**
galvanized steel
opening: 80 mm
weight: 800 g



AF 610

AF 600

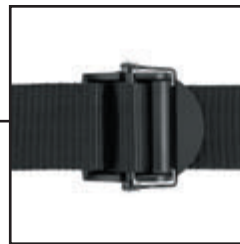

alu buckle

steel buckle

AF 600, AF 610 WORK POSITIONING LANYARD

EN 358



Ref.: AF 600, AF 610

AF 600 (steel buckle) - max. length 1,5m

AF 610 (alu buckle) - max. length 1,5m

OTHER LENGHTES ON REQUEST

Material: Poliester

Work positioning

PB-20 work positioning belt

EN 358



Ref.: AP 020

Belt with two side attaching buckles.
Size: M-XL - 670g
XXL - 690g



PB-70 work positioning belt

EN 358 EN 813



Ref.: AP 070

Belt with two side attaching buckles and and attaching point for sitting position.
Size: M-XL - 990g
XXL - 1020g



PB-10 work positioning belt

EN 358



Ref.: AP 010

Belt with two side attaching buckles.
Size: M-XL - 460g
XXL - 480g



PB-11 work positioning belt

EN 358



Ref.: AP 011

Belt with two side attaching buckles and one real attaching buckle.
Size: M-XL - 470g
XXL - 490g



PB-31 fireman belt

EN 358



Size: M-XL - 900g
XXL - 1000g

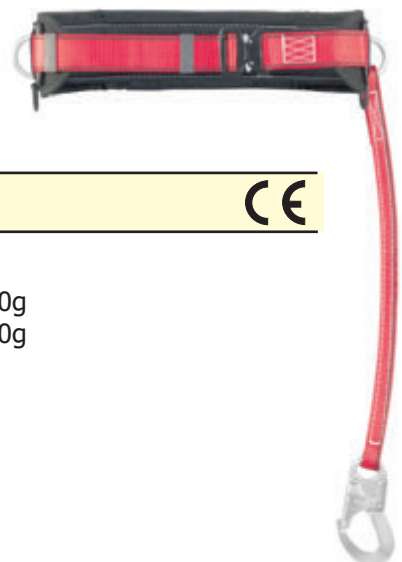

Work positioning

TH-020 work positioning belt **FOR TREES CLIMBERS**



EN 358, EN 813



Ref.: TH 020

Belt with two side attaching buckles.
Size: M-XL - 1450g
XXL - 1490g

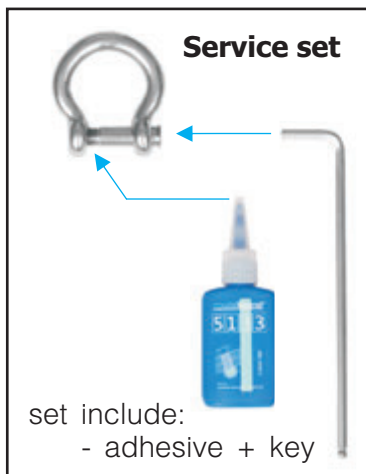

TH-050 work positioning belt **FOR TREES CLIMBERS**



EN 358, EN 813



Ref.: TH 050

Belt with two side attaching buckles.
Automatic alu buckle.
Size: M-XL - 2500g
XXL - 2600g



TH-030 work positioning belt **FOR TREES CLIMBERS**



EN 358, EN 813



Ref.: TH 030

Belt with two side attaching buckles.
Automatic alu buckle.
Size: M-XL - 1780g
XXL - 1820g



Fall arresters

retractable type

CR 240 steel cable retractor

NEW!

EN 360



- Ref.: CR 240 06 - cable length 6m
- Ref.: CR 240 10 - cable length 10m
- Ref.: CR 240 12 - cable length 12m
- Ref.: CR 240 15 - cable length 15m

Built in brake with energy dissipating mechanism inside durable plastic housing.

Static strength: not less 12kN
Braking force: less than 6kN

Weight:

- CR 240 06 - weight 4,10kg
- CR 240 10 - weight 4,30kg
- CR 240 12 - weight 4,90kg
- CR 240 15 - weight 5,10kg

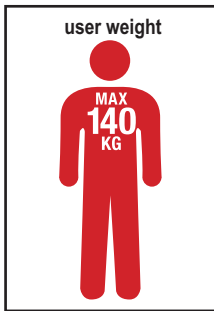

SWIVEL SNAP HOOKS



AZ 030
aluminium,
galvanized steel
opening: 23 mm
weight: 200 g



AZ 031T
aluminium,
galvanized steel
opening: 23 mm
twist lock



AZ 050
galvanized steel
opening: 23 mm
weight: 360 g



AZ 051T
galvanized steel
opening: 23 mm
weight: 360 g



AZ 002AS
aluminium,
galvanized steel
opening: 24 mm
weight: 215 g



AZ 060
galvanized steel
opening: 21 mm
weight: 380 g

SWIVEL SNAP HOOKS WITH FALL INDICATOR



AZ 030I
with indicator
aluminium,
galvanized steel
opening: 23 mm
weight: 200 g



AZ 031TI
with indicator
aluminium,
galvanized steel
opening: 23 mm
weight: 200 g



AZ 002ASI
with indicator
aluminium,
galvanized steel
opening: 24 mm
weight: 220 g



AZ 060I
with indicator
galvanized steel
opening: 21 mm
weight: 380 g

Fall arresters

retractable type

CRW 300

NEW!

retractable type fall arrester with rescue lifting device

EN 360, EN 1496 class B



Ref.: CRW 300 25 - cable length 25m

Cable material: galvanized steel
Maximum cable length: 25m
Case material: aluminium alloy
Max working load: 100 kg
Weight: approx 15 kg

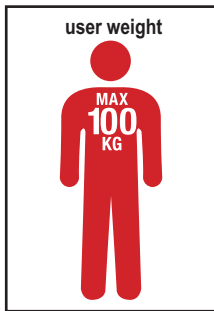

zinc galvanized steel cable

SWIVEL SNAP HOOKS



AZ 030
aluminium,
galvanized steel
opening: 23 mm
weight: 200 g



AZ 031T
aluminium,
galvanized steel
opening: 23 mm
weight: 200 g
twist lock



AZ 050
galvanized steel
opening: 23 mm
weight: 360 g



AZ 051T
galvanized steel
opening: 23 mm
weight: 360 g



AZ 002AS
aluminium,
galvanized steel
opening: 24 mm
weight: 215 g



AZ 060
galvanized steel
opening: 21 mm
weight: 380 g

SWIVEL SNAP HOOKS WITH FALL INDICATOR



AZ 030I
with indicator
aluminium,
galvanized steel
opening: 23 mm
weight: 200 g



AZ 031TI
with indicator
aluminium,
galvanized steel
opening: 23 mm
weight: 200 g



AZ 002ASI
with indicator
aluminium,
galvanized steel
opening: 24 mm
weight: 220 g



AZ 060I
with indicator
galvanized steel
opening: 21 mm
weight: 380 g

Fall arresters

retractable type

CR 200

steel cable retractor

EN 360



- Ref.: CR 200 06 - cable length 6m
- Ref.: CR 200 10 - cable length 10m
- Ref.: CR 200 12 - cable length 12m
- Ref.: CR 200 15 - cable length 15m

Dimensions: 208 x 85 x 280 mm

Weight:

- CR 200 06 - weight 5,10kg
- CR 200 10 - weight 5,30kg
- CR 200 12 - weight 5,90kg
- CR 200 15 - weight 6,10kg

plastic case



holder / anchor point

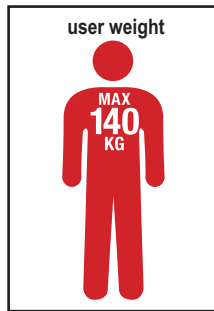

stainless steel ring

zinc galvanized steel cable
Ø 4mm

SWIVEL SNAP HOOKS

grey & black



AZ 030
aluminium,
galvanized steel
opening: 23 mm
weight: 200 g



AZ 031T
aluminium,
galvanized steel
opening: 23 mm
weight: 200 g
twist lock



AZ 050
galvanized steel
opening: 23 mm
weight: 360 g



AZ 051T
galvanized steel
opening: 23 mm
weight: 360 g



AZ 002AS
aluminium,
galvanized steel
opening: 24 mm
weight: 215 g



AZ 060
galvanized steel
opening: 21 mm
weight: 380 g

SWIVEL SNAP HOOKS WITH FALL INDICATOR

AZ 030I
with indicator
aluminium,
galvanized steel
opening: 23 mm
weight: 200 g



AZ 031TI
with indicator
aluminium,
galvanized steel
opening: 23 mm
weight: 200 g

AZ 002ASI
with indicator
aluminium,
galvanized steel
opening: 24 mm
weight: 220 g



AZ 060I
with indicator
galvanized steel
opening: 21 mm
weight: 380 g



Fall arresters

retractable type

CR 210

steel cable retractor
metal case

EN 360



Ref.: CR 210 06 - cable length 6m
 Ref.: CR 210 10 - cable length 10m
 Ref.: CR 210 12 - cable length 12m
 Ref.: CR 210 15 - cable length 15m
 Dimensions: 208 x 85 x 280 mm
 Weight:
 CR 210 06 - weight 5,30kg
 CR 210 10 - weight 5,50kg
 CR 210 12 - weight 6,20kg
 CR 210 15 - weight 6,50kg

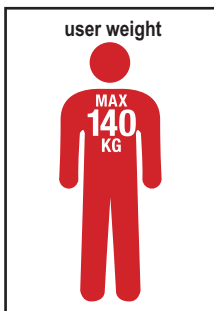

SWIVEL SNAP HOOKS



AZ 030
aluminium,
galvanized steel
opening: 23 mm
weight: 200 g



AZ 031T
aluminium,
galvanized steel
opening: 23 mm
weight: 200 g
twist lock



AZ 050
galvanized steel
opening: 23 mm
weight: 360 g



AZ 051T
galvanized steel
opening: 23 mm
weight: 360 g



AZ 002AS
aluminium,
galvanized steel
opening: 24 mm
weight: 215 g



AZ 060
galvanized steel
opening: 21 mm
weight: 380 g

SWIVEL SNAP HOOKS WITH FALL INDICATOR



AZ 030I
with indicator
aluminium,
galvanized steel
opening: 23 mm
weight: 200 g



AZ 031TI
with indicator
aluminium,
galvanized steel
opening: 23 mm
weight: 200 g



AZ 002ASI
with indicator
aluminium,
galvanized steel
opening: 24 mm
weight: 220 g



AZ 060I
with indicator
galvanized steel
opening: 21 mm
weight: 380 g

Fall arresters

retractable type

CR 220

steel cable retractor
AISI steel components

EN 360



- Ref.: CR 220 06 - cable length 6m
 Ref.: CR 220 08 - cable length 8m
 Ref.: CR 220 10 - cable length 10m
 Ref.: CR 220 11 - cable length 11m
- Dimensions: 208 x 85 x 280 mm
 Weight:
 CR 220 06 - weight 5,10kg
 CR 220 08 - weight 5,30kg
 CR 220 10 - weight 5,50kg
 CR 220 11 - weight 5,90kg

plastic case

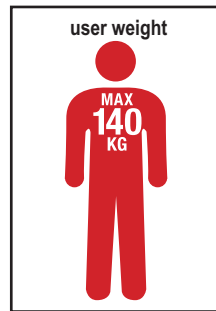
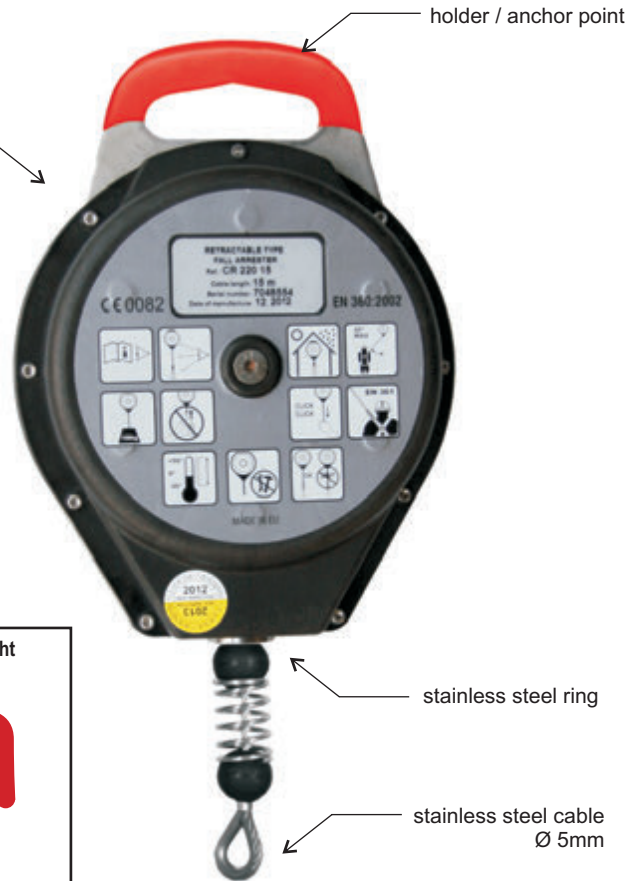

SWIVEL SNAP HOOKS



AZ 030
 aluminium,
 galvanized steel
 opening: 23 mm
 weight: 200 g



AZ 031T
 aluminium,
 galvanized steel
 opening: 23 mm
 weight: 200 g
 twist lock



AZ 050
 galvanized steel
 opening: 23 mm
 weight: 360 g



AZ 051T
 galvanized steel
 opening: 23 mm
 weight: 360 g



AZ 002AS
 aluminium,
 galvanized steel
 opening: 24 mm
 weight: 215 g



AZ 060
 galvanized steel
 opening: 21 mm
 weight: 380 g

SWIVEL SNAP HOOKS WITH FALL INDICATOR



AZ 030I
 with indicator
 aluminium,
 galvanized steel
 opening: 23 mm
 weight: 200 g



AZ 031TI
 with indicator
 aluminium,
 galvanized steel
 opening: 23 mm
 weight: 200 g



AZ 002ASI
 with indicator
 aluminium,
 galvanized steel
 opening: 24 mm
 weight: 220 g



AZ 060I
 with indicator
 galvanized steel
 opening: 21 mm
 weight: 380 g

Fall arresters

retractable type

WR 100 NEW

WEBBING RETRACTOR 6 m

EN 360



Ref.: WR 100 06 - working length 6 m

Dimensions: 160 x 70 x 230 mm

Locking after conditioning: (+50)°C; (-30)°C; wet.

Weight brutto: 1,70 kg (with snap hook)

Weight netto: 1,50 kg (without snap hook)

ADVANTAGES:

- Double swivel!

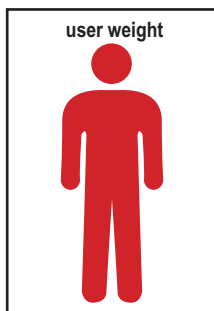

AZ 002ASI
weight: 220 g
hot forged
alu alloy 7075 T6



Fall arresters

retractable type

WR 100 NEW

WEBBING RETRACTOR 6 m

EN 360



Ref.: WR 100 06 - working length 6 m

Dimensions: 160 x 70 x 230 mm

Locking after conditioning: (+50)°C; (-30)°C; wet.

Weight brutto: 1,70 kg (with snap hook)

Weight netto: 1,50 kg (without snap hook)

ADVANTAGES:

- Double swivel!
- snap hook AZ 011

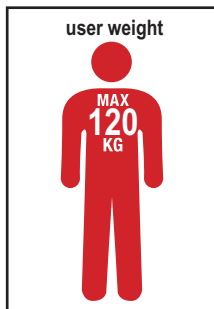

Fall arresters

retractable type

WR 200

WEBBING RETRACTOR

EN 360



Ref.: WR 200 06 - webbing length 6m
 Dimensions: 208 x 85 x 280 mm
 Weight: 4,70kg

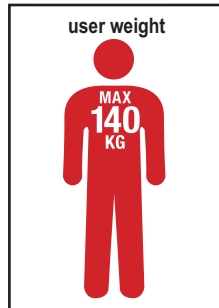

SWIVEL SNAP HOOKS



AZ 030
aluminium,
galvanized steel
opening: 23 mm
weight: 200 g



AZ 031T
aluminium,
galvanized steel
opening: 23 mm
weight: 200 g
twist lock



AZ 050
galvanized steel
opening: 23 mm
weight: 360 g



AZ 051T
galvanized steel
opening: 23 mm
weight: 360 g



AZ 002AS
aluminium,
galvanized steel
opening: 24 mm
weight: 215 g



AZ 060
galvanized steel
opening: 21 mm
weight: 380 g

SWIVEL SNAP HOOKS WITH FALL INDICATOR



AZ 030I
with indicator
aluminium,
galvanized steel
opening: 23 mm
weight: 200 g



AZ 031TI
with indicator
aluminium,
galvanized steel
opening: 23 mm
weight: 200 g



AZ 002ASI
with indicator
aluminium,
galvanized steel
opening: 24 mm
weight: 220 g



AZ 060I
with indicator
galvanized steel
opening: 21 mm
weight: 380 g

Fall arresters

retractable type

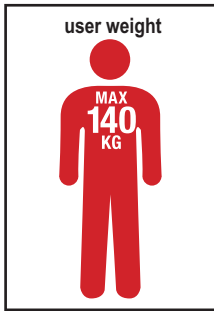

plastic case

holder / anchor point



zinc galvanized steel cable
Ø 4 mm

CR 300 STEEL CABLE RETRACTOR

EN 360



- Ref.: CR 300 18 - cable length 18m
- Ref.: CR 300 20 - cable length 20m
- Ref.: CR 300 25 - cable length 25m
- Ref.: CR 300 28 - cable length 28m

Dimensions: 260 x 120 x 340 mm

Weight:

- CR 300 18 - weight 11,15kg
- CR 300 20 - weight 11,25kg
- CR 300 25 - weight 11,50kg
- CR 300 28 - weight 11,65kg

SWIVEL SNAP HOOKS



AZ 030
aluminium,
galvanized steel
opening: 23 mm
weight: 200 g



AZ 031T
aluminium,
galvanized steel
opening: 23 mm
weight: 200 g
twist lock



AZ 050
galvanized steel
opening: 23 mm
weight: 360 g



AZ 051T
galvanized steel
opening: 23 mm
weight: 360 g



AZ 002AS
aluminium,
galvanized steel
opening: 24 mm
weight: 215 g



AZ 060
galvanized steel
opening: 21 mm
weight: 380 g

SWIVEL SNAP HOOKS WITH FALL INDICATOR



AZ 030I
with indicator
aluminium,
galvanized steel
opening: 23 mm
weight: 200 g



AZ 031TI
with indicator
aluminium,
galvanized steel
opening: 23 mm
weight: 200 g



AZ 002ASI
with indicator
aluminium,
galvanized steel
opening: 24 mm
weight: 220 g



AZ 060I
with indicator
galvanized steel
opening: 21 mm
weight: 380 g

Fall arresters

retractable type

ROLEX WEBBING RETRACTOR **NEW**

EN 360



Ref.: AH 210

- **AH 210**
Dimensions: (without snap hooks) 96 x 98 x 320mm
Maximum working length of device: **2260mm**
Weight: 1180g
- **AH 220**
Dimensions: (without snap hooks) 96 x 98 x 320mm
Maximum working length of device: **2370mm**
Weight: 1500g
- **AH 220s**
Dimensions: (without snap hooks) 96 x 98 x 320mm
Maximum working length of device: **2415mm**
Weight: 1680g

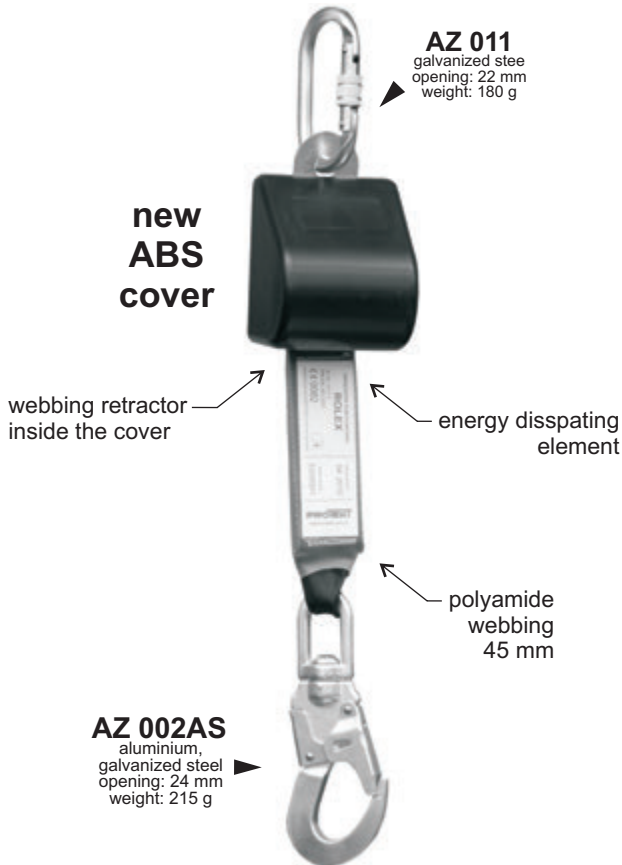

Ref.: AH 220s
ROLEX + AZ 022s

Ref.: AH 220
ROLEX + AZ 022

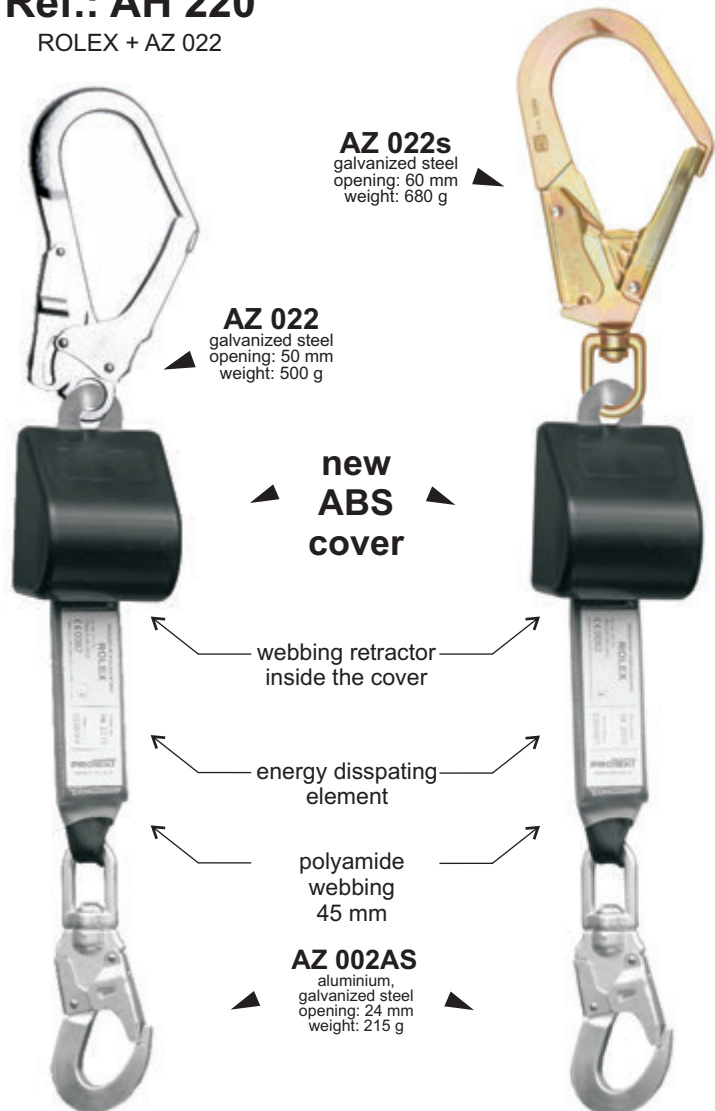

available colors

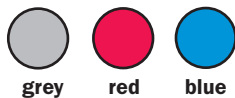

Fall arresters

retractable type

WR 025 **NEW**

RETRACTABLE TYPE FALL ARRESTER

EN 360 + HORIZONTAL USE ACC. TO 11.054 

Ref.: **WR 025**

Length: 2,35m

Weight: 850g + weight of snap hook

Static strength: not less 15 kN

Braking force: less than 6 kN

Fall arresters height: less than 2m

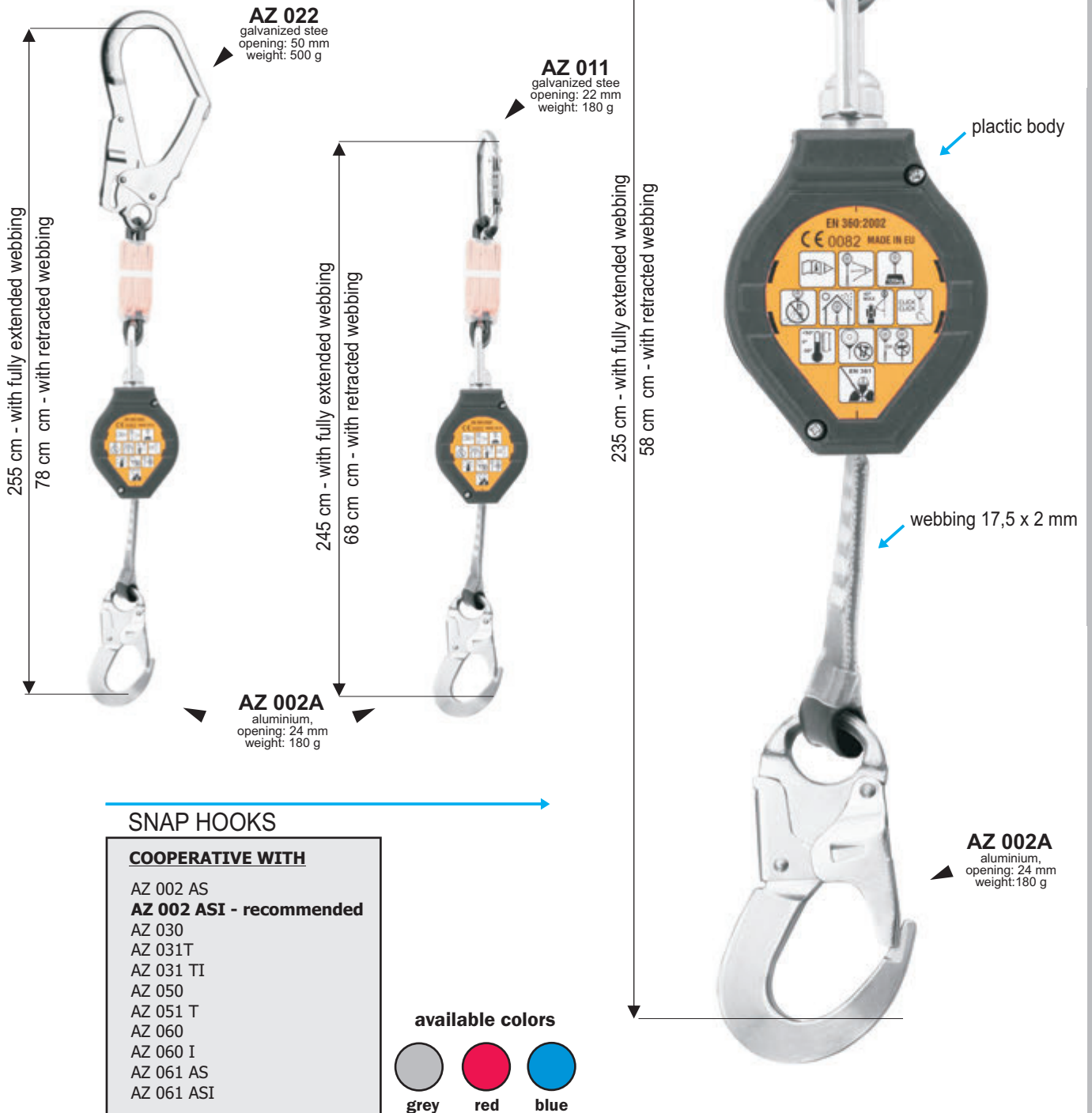

SNAP HOOKS

COOPERATIVE WITH

- AZ 002 AS
- AZ 002 ASI - recommended**
- AZ 030
- AZ 031T
- AZ 031 TI
- AZ 050
- AZ 051 T
- AZ 060
- AZ 060 I
- AZ 061 AS
- AZ 061 ASI

available colors

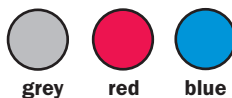

Fall arresters

retractable type

CR 30 NEW

STEEL CABLE RETRACTOR

EN 360



Ref.: CR 30

Max. working length: 3m
 Weight: 1750g
 Diameter cable: 4mm
 Static strength: not less 12 kN
 Braking force: less than 6 kN

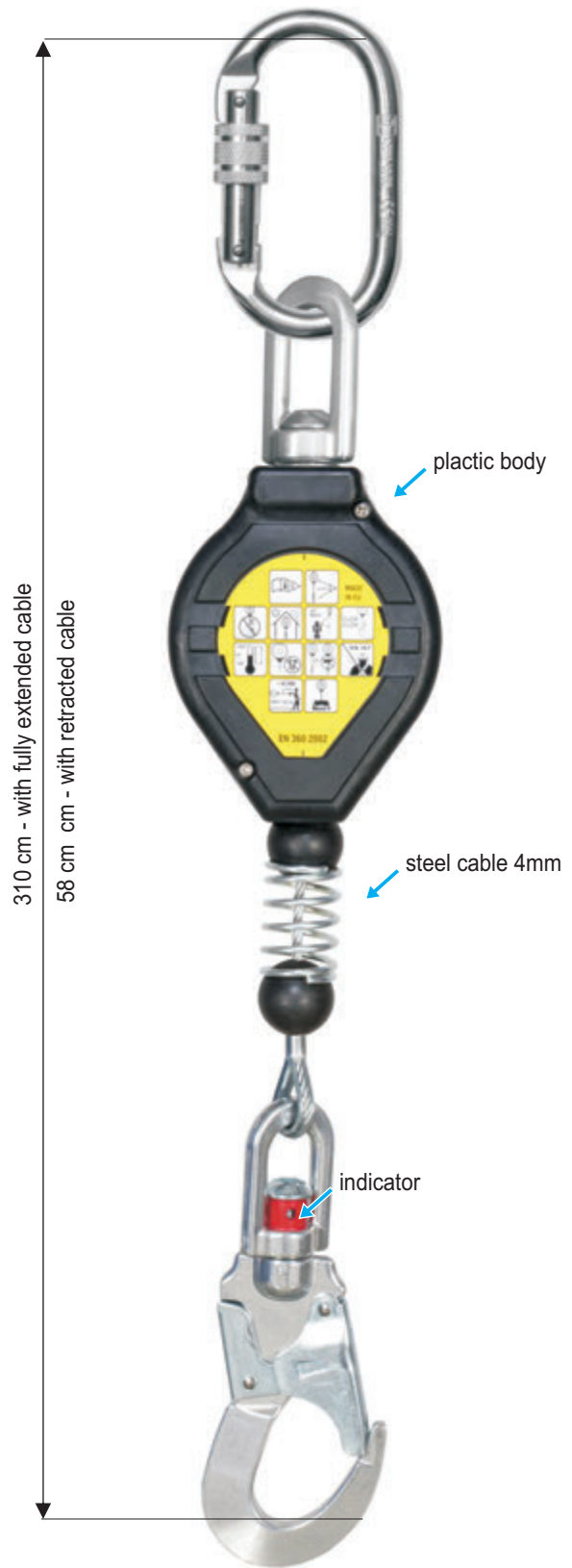
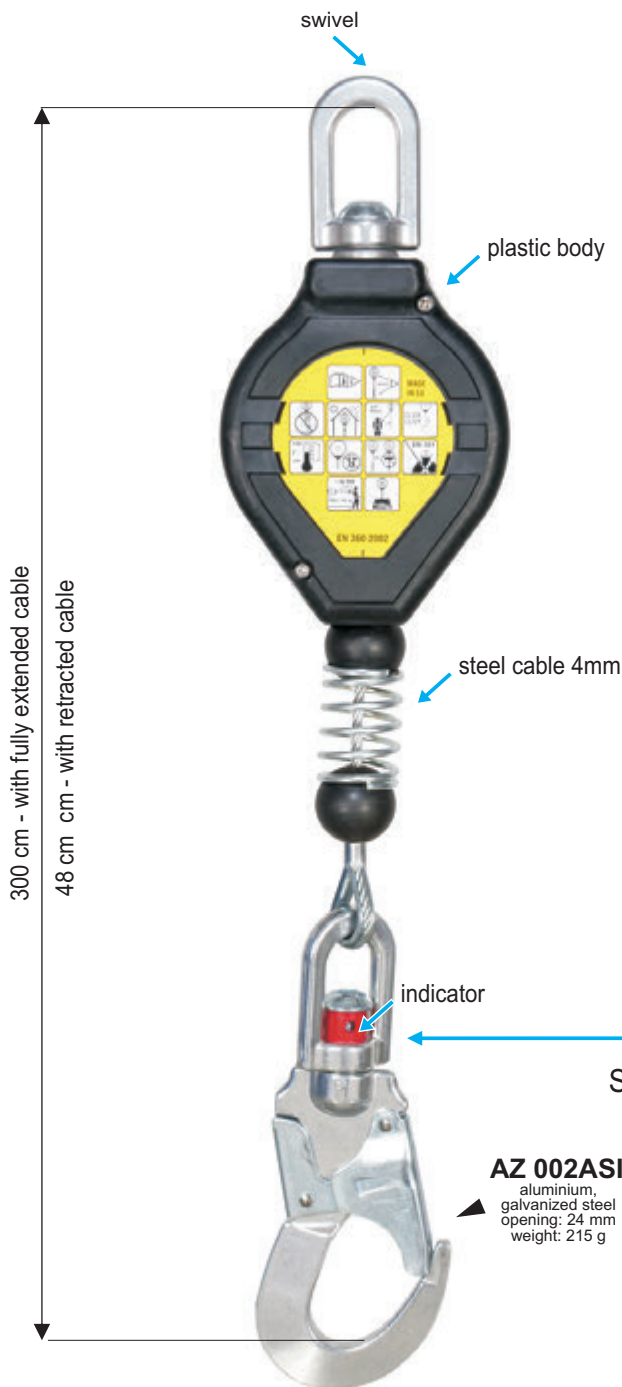

SNAP HOOK WITH SWIVEL FUNCTION AND BUILT IN FALL INDICATOR

AZ 002ASI
 aluminium,
 galvanized steel
 opening: 24 mm
 weight: 215 g

COOPERATIVE WITH

- AZ 002 A
- AZ 002 ASI
- AZ 030
- AZ 031T
- AZ 031 TI
- AZ 050
- AZ 051 T
- AZ 060
- AZ 060 I
- AZ 061 AS
- AZ 061 ASI

Mobile man anchor

IM 200

EN 795 E



Ref.: IM 200

Material: fire zinc galvanized steel
12 units per set
Destiny: for 2 person



TOTAL WEIGHT: 374 kg

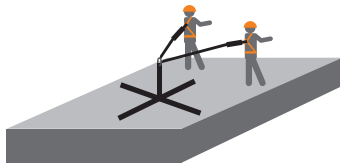

Destiny: for 2 person

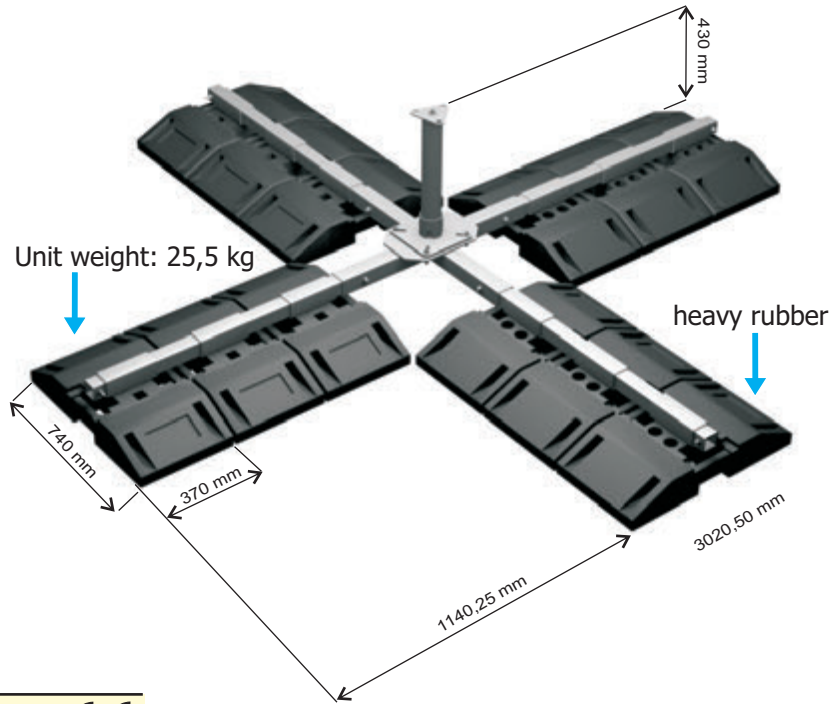

IM 100

EN 795 E



Ref.: IM 100

Material: fire zinc galvanized steel
12 units per set
Destiny: for 1 person

TOTAL WEIGHT: 260 kg

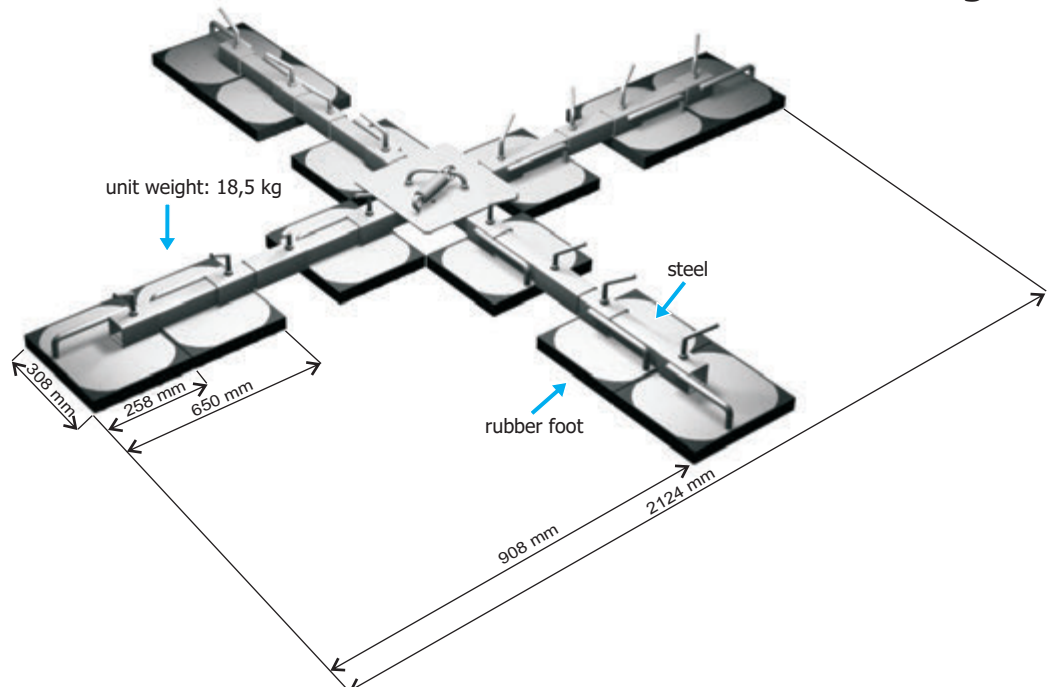

Fall arresters

retractable type

AZ 800

ROOF LANYARD FOR HORIZONTAL USE CR 200 and CR 300

EN 360 According to new regulation - PPE Directive's 89/686/EEC Proposal for Enquiry CNB/11.60.

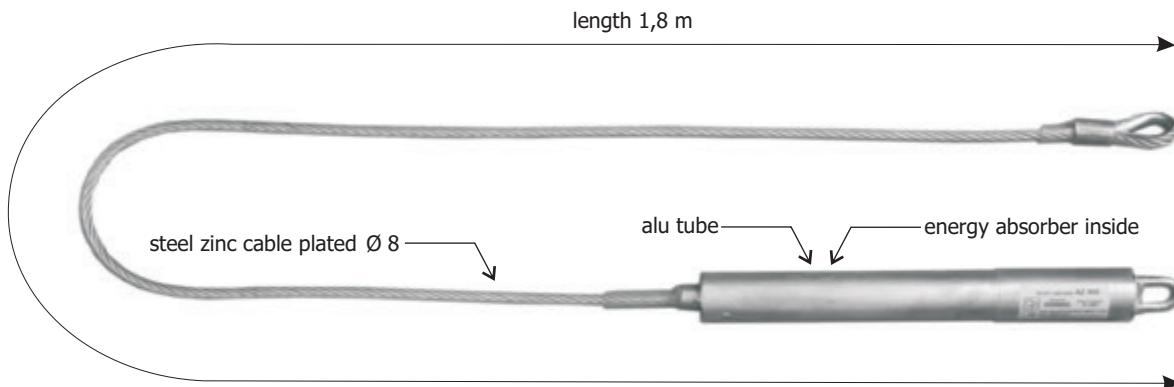

APAVE permission only with CR 200 and CR 300 certificates.

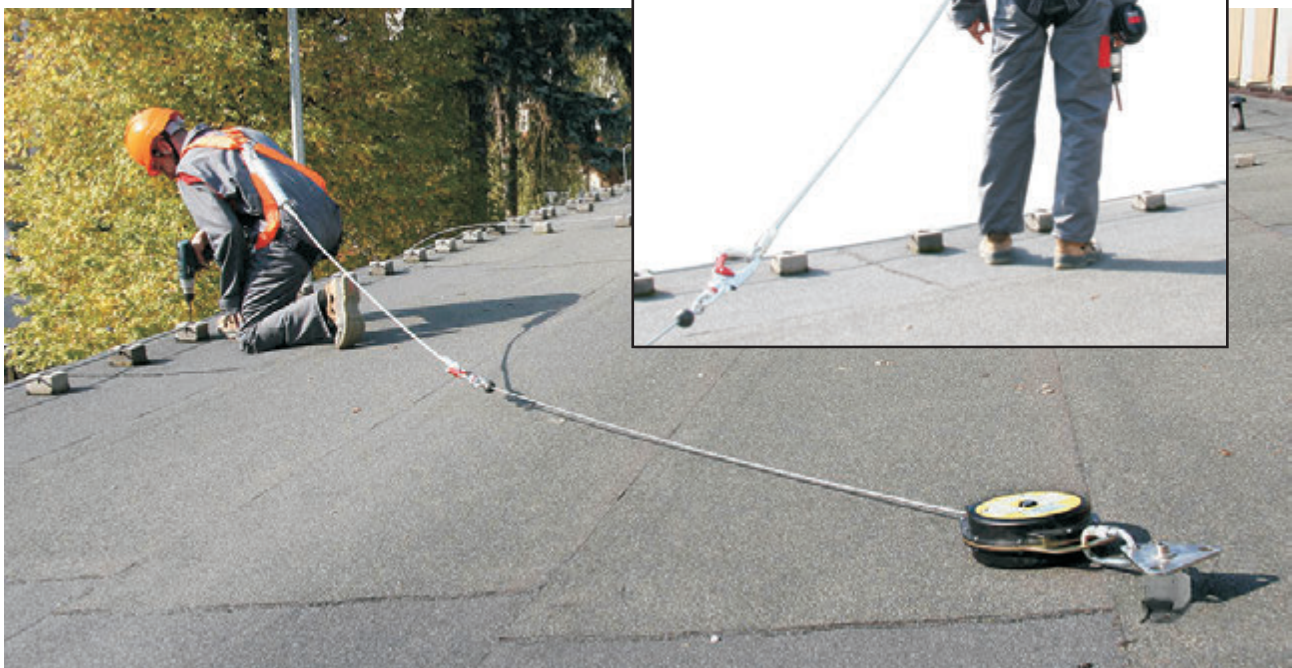

Horizontal lifelines

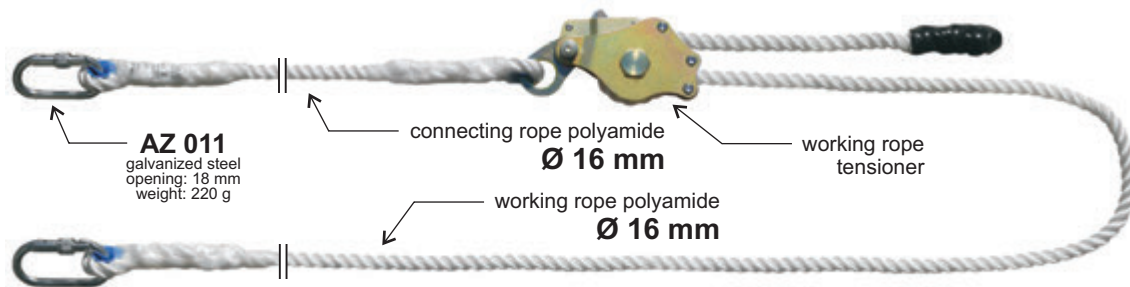

ADJUSTING THE LENGTH AND THE TENSION THE HORIZONTAL LIFE LINE

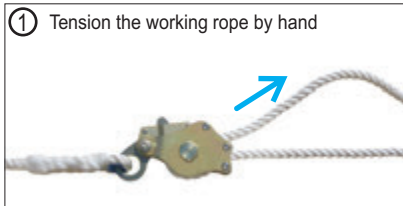

DISASSEMBLY OF THE HORIZONTAL LIFELINE

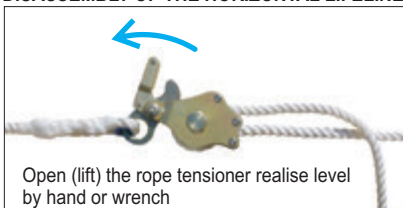

AE 300 ADJUSTABLE HORIZONTAL LIFELINE

EN 795



Ref.: AE 300 10 - device length 10 m
Ref.: AE 300 20 - device length 20 m
Other lengths on request.

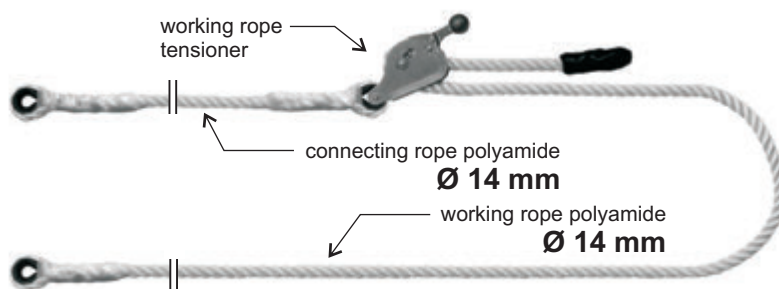
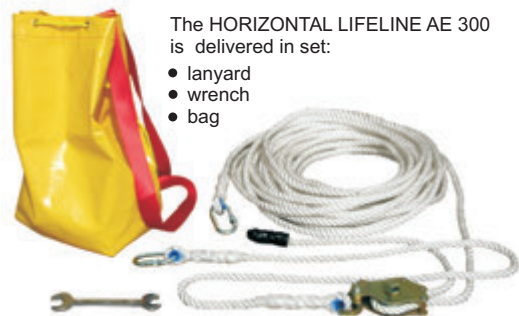

LP 120 ADJUSTABLE HORIZONTAL LIFELINE

EN 795



Ref.:
LP 120 05 - device length 5m
LP 120 10 - device length 10m
LP 120 15 - device length 15m
LP 120 20 - device length 20m
Other lengths on request.

ADJUSTING THE LENGTH AND THE TENSION THE HORIZONTAL LIFE LINE



DISASSEMBLY OF THE HORIZONTAL LIFELINE



Horizontal lifelines

AZ 002
galvanized steel
opening: 18 mm
weight: 220 g



AZ 003
aluminium
opening: 20 mm
weight: 160 g



AZ 004
aluminium
opening: 22 mm
weight: 180 g
twist lock



AZ 040
aluminium
opening: 23 mm
weight: 80 g



AZ 041T
aluminium
opening: 23 mm
weight: 100 g
twist lock



AZ 020
galvanized steel
opening: 23 mm
weight: 230 g



AZ 021T
galvanized steel
opening: 23 mm
weight: 250 g
twist lock



AZ 022
galvanized steel
opening: 50 mm
weight: 500 g



AZ 023
aluminium
opening: 60 mm
weight: 480 g



AZ 024
aluminium
opening: 100 mm
weight: 920 g



AZ 025
galvanized steel
opening: 80 mm
weight: 800 g

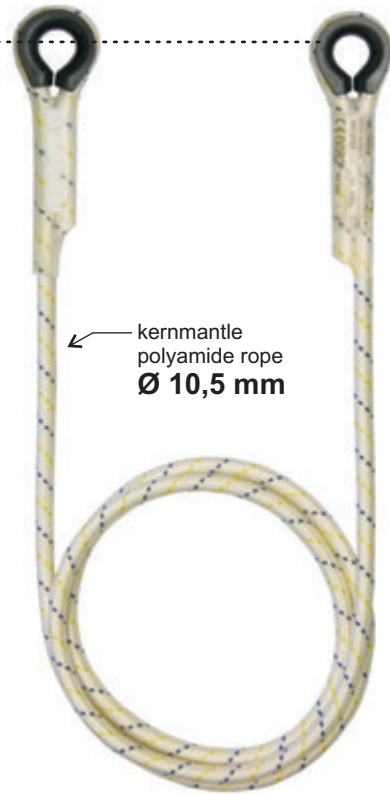

kernmantle
polyamide rope
Ø 10,5 mm

LP 100 TT horizontal lifeline

EN 795



Ref.: LP 100 xx TT (xx - length)

Standards:

- LP 100 02 TT - length 2,5m
- LP 100 05 TT - length 5m
- LP 100 10 TT - length 10m
- LP 100 15 TT - length 15m
- LP 100 20 TT - length 20m
- LP 100 25 TT - length 25m
- LP 100 30 TT - length 30m

Horizontal lifelines

AZ 002
galvanized steel
opening: 18 mm
weight: 220 g



AZ 003
aluminium
opening: 20 mm
weight: 160 g



AZ 004
aluminium
opening: 22 mm
weight: 180 g
twist lock



AZ 040
aluminium
opening: 23 mm
weight: 80 g



AZ 041T
aluminium
opening: 23 mm
weight: 100 g
twist lock



AZ 020
galvanized steel
opening: 23 mm
weight: 230 g



AZ 021T
galvanized steel
opening: 23 mm
weight: 250 g
twist lock



AZ 022
galvanized steel
opening: 50 mm
weight: 500 g



AZ 023
aluminium
opening: 60 mm
weight: 480 g



AZ 024
aluminium
opening: 100 mm
weight: 920 g



AZ 025
galvanized steel
opening: 80 mm
weight: 800 g



kernmantle
polyamide rope
ø10,5mm

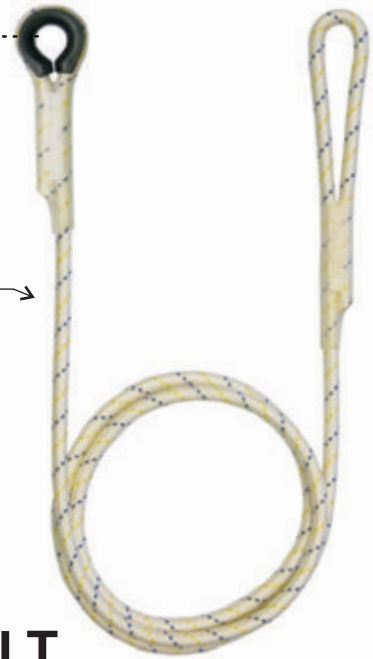

LP 100 LT horizontal lifeline

EN 795



Ref.: LP 100 xx LT (xx - length)

Standards:

- LP 100 02 LT - length 2,5m
- LP 100 05 LT - length 5m
- LP 100 10 LT - length 10m
- LP 100 15 LT - length 15m
- LP 100 20 LT - length 20m
- LP 100 25 LT - length 25m
- LP 100 30 LT - length 30m

kernmantle
polyamide rope
ø10,5mm

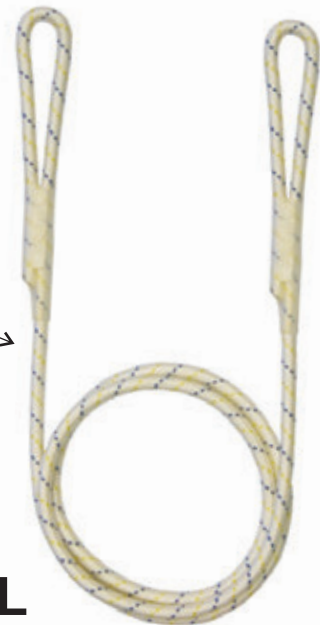

LP 100 LL horizontal lifeline

EN 795



Ref.: LP 100 xx LL (xx - length)

Standards:

- LP 100 02 LL - length 2,5m
- LP 100 05 LL - length 5m
- LP 100 10 LL - length 10m
- LP 100 15 LL - length 15m
- LP 100 20 LL - length 20m
- LP 100 25 LL - length 25m
- LP 100 30 LL - length 30m

Horizontal anchor lines

Aramid rope

AZ 002
galvanized steel
opening: 18 mm
weight: 220 g



AZ 002A
aluminium,
galvanized steel
opening: 24 mm
weight: 180 g



AZ 003
aluminium
opening: 20 mm
weight: 160 g



AZ 011
galvanized steel
opening: 22 mm
weight: 180 g



AZ 022
galvanized steel
opening: 50 mm
weight: 500 g



AZ 023
aluminium
opening: 60 mm
weight: 480 g



AZ 024
aluminium
opening: 100 mm
weight: 920 g



AZ 025
galvanized steel
opening: 80 mm
weight: 800 g



regulating buckle

ARAMID rope
with polyamide core;
Ø 11 mm

LP 200 FLR adjustable horizontal anchor line

EN 795 B



Ref.: LP 200 FLR (xx - length)

LP 200 05 - regulation length 2,5 - 5,0m

LP 200 10 - regulation length 5,0 - 10,0m

LP 200 20 - regulation length 10,0 - 20,0m

Material: Aramid rope with polyamide core;

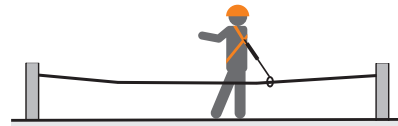

ATTENTION:

For hot works
like welding,
grinding, soldering
metal cutting.

The rope is protected
against sparks,
molten metal drops, etc.

EN 358 p.4.1.5
resistance to flame



Horizontal adjustable webbing

AE 320

safety horizontal webbing

EN 795 Class B



Ref.: AE 320 10 - max. 10 m

Ref.: AE 320 20 - max. 20 m

Other lengths on request.

1. Adjustable length
2. Colours of webbing:
 - blue
 - yellow
 - black

3. For 3 persons working in same time

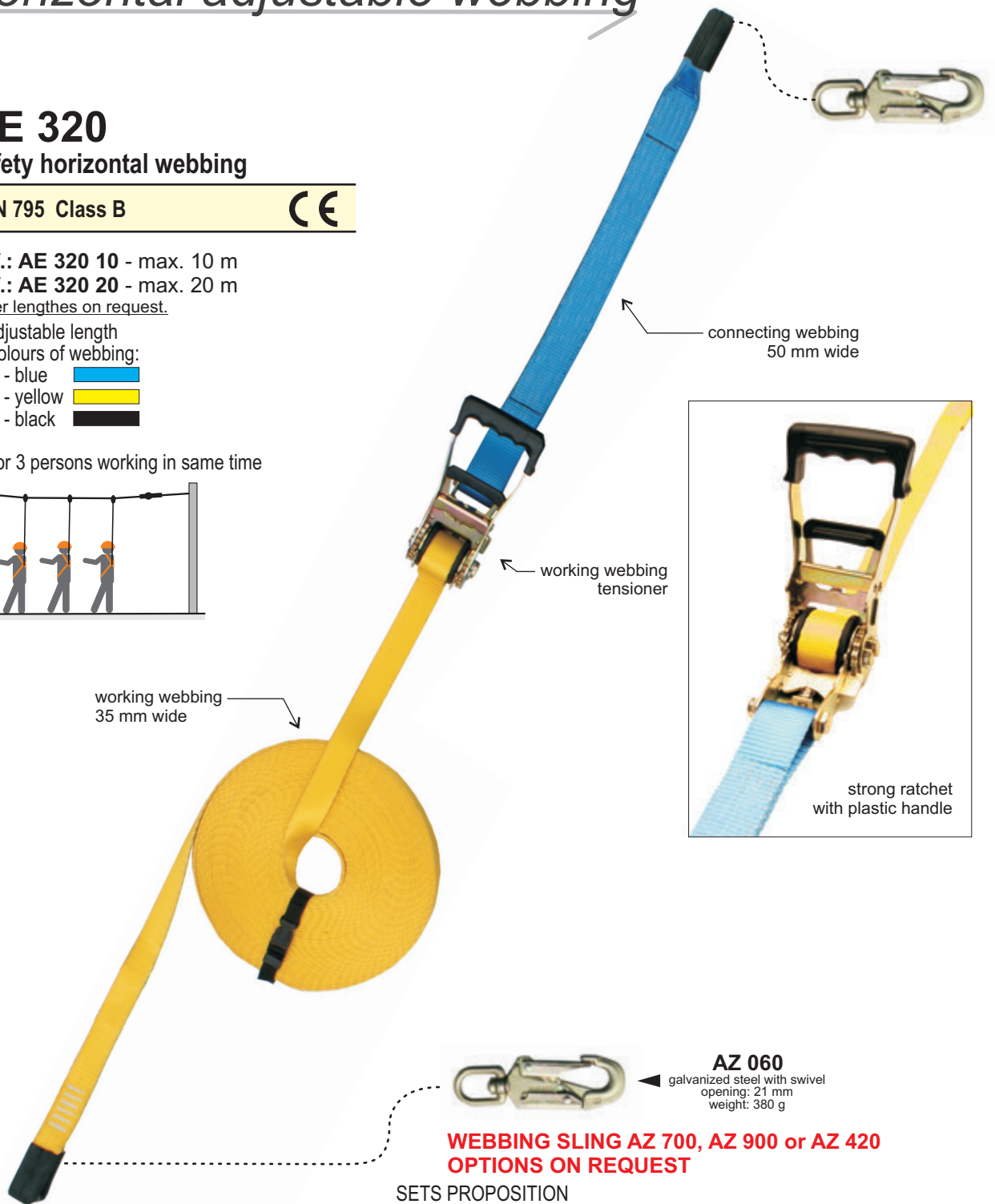
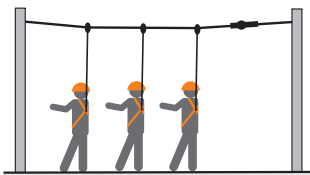

SETS PROPOSITION

Sewed bag for AE 320 - sewed to connecting webbing

Separate bag for AE 320 made of PVC



ref.: AX 050

Other colours of the bags on request



ref.: AX 011

Other colours of the bags on request

Lanyard edges protector

AX 902

COVER THE EDGES



Ref.: AX 902

Dimensions: 120 x 175,5 mm

Weight: 0,85kg

Material: stainless steel

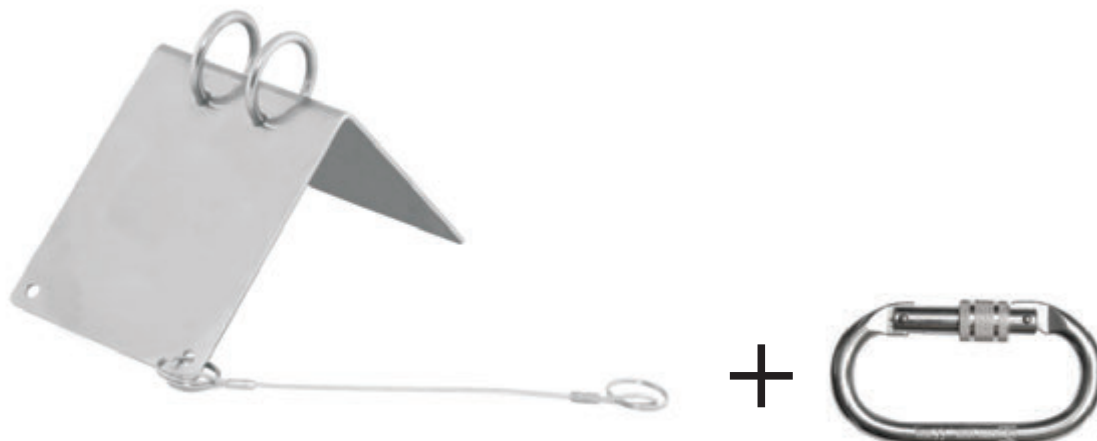

AX 903

COVER THE EDGES



Ref.: AX 903

Dimensions: 180 x 175,5 mm

Weight: 1,30kg

Material: stainless steel

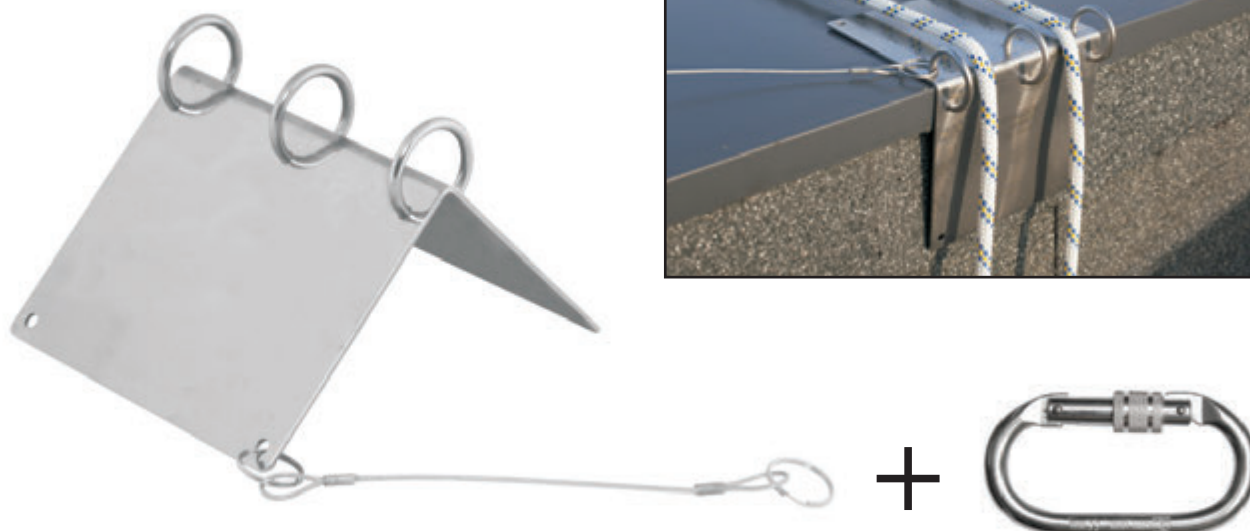

Lanyard edges protector

AX 904

COVER THE EDGES

NEW



Ref.: AX 904

Parameters:

AX 904 01 - 1 module

weight: 0,37 kg

Lmax = 70 mm

AX 904 03 - set of 3 modules

weight: 1,10 kg

Lmax = 240 mm

AX 904 04 - set of 4 modules

weight: 1,48 kg

Lmax = 325 mm

Material: aluminum, stainless steel, brass

Application: Steel or concrete structural beams with sharp edges. Lanyard up to $\varnothing 14$ mm.

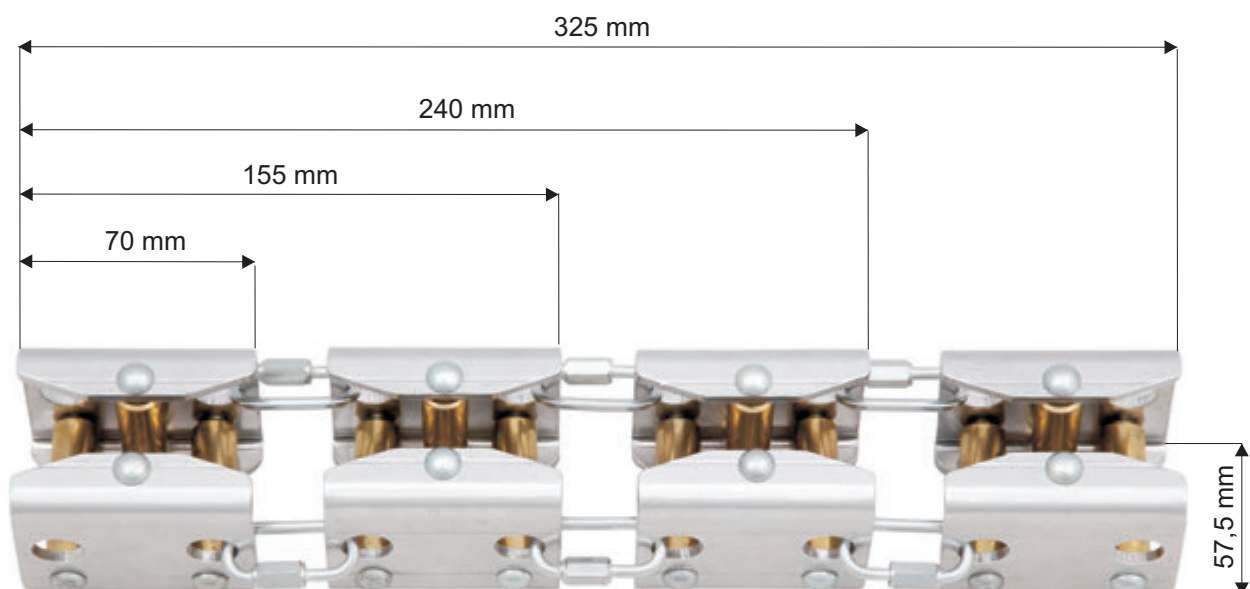
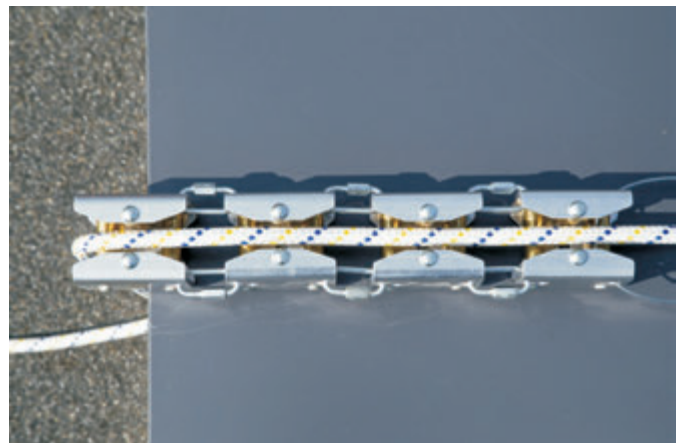

Lanyard edges protector

AX 905

COVER THE EDGES

NEW



Ref.: AX 905

Parameters:

weight: 0,62 kg
Lmax = 300 mm

Material: polyamide, steel

Application: Steel or concrete structural beams
with sharp edges. Lanyard up to $\varnothing 18$ mm.

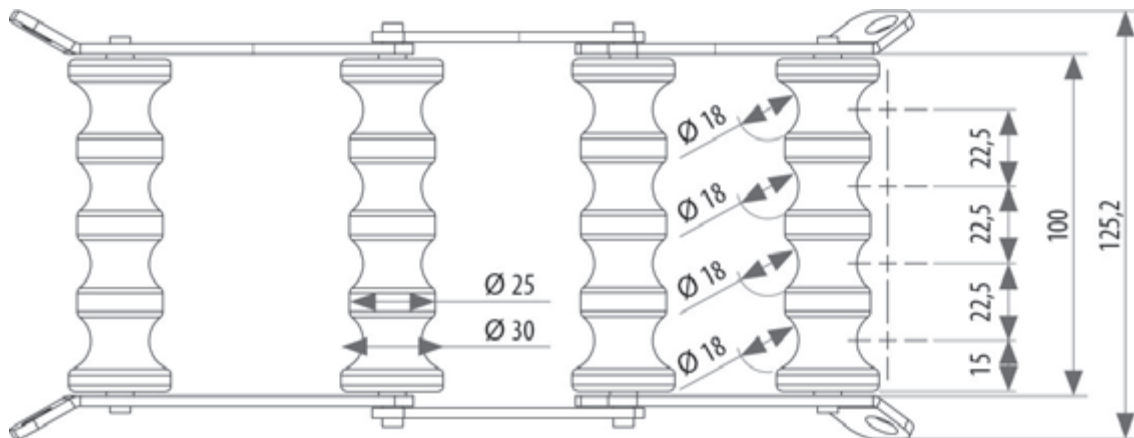
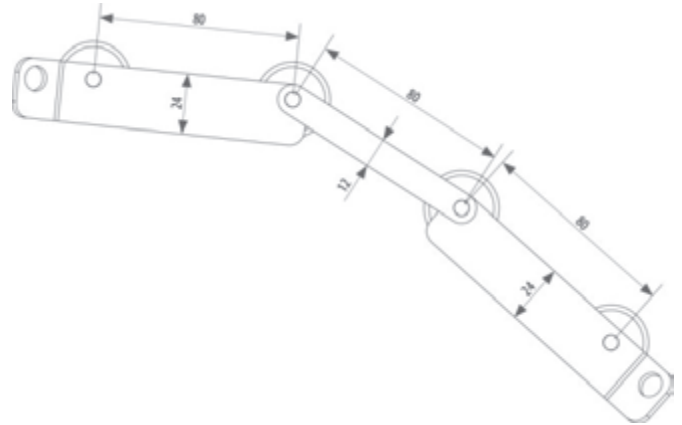

4 x up to $\varnothing 18$ mm lanyard



Lanyard edges protector

AX 907

COVER THE EDGES

NEW



Ref.: AX 907

Parameters:

AX 907 01 - 1 module

weight: 0,30 kg

Lmax = 90 mm

AX 907 03 - set of 3 modules

weight: 0,90 kg

Lmax = 300 mm

AX 907 04 - set of 4 modules

weight: 1,20 kg

Lmax = 405 mm

Material: aluminum, stainless steel

Application: Steel or concrete structural beams with sharp edges.



Lanyard edges protector

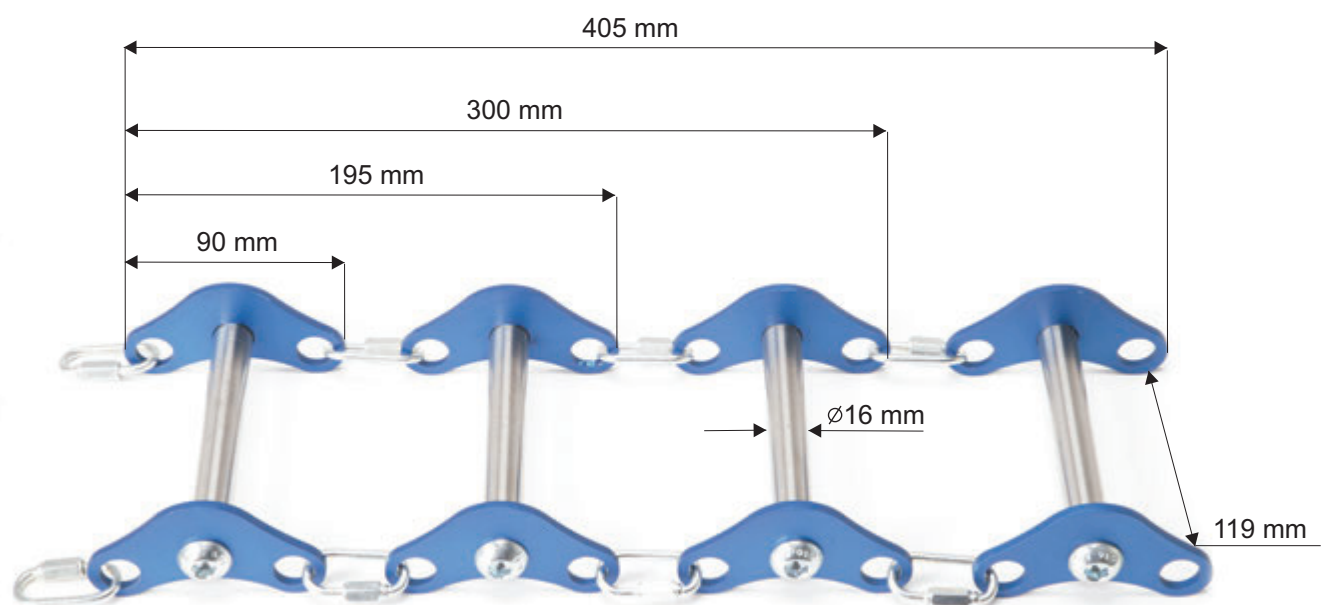

Permanent anchor point

AT 182-1 **NEW** PERMANENT ANCHOR POINT

EN 795 A



Ref.: AT 182-1

Weight: 4,5kg

Material: stainless steel - AISI 304

Static strength: 12 kN

Fixing hole: 12,5 mm

Protection for one person.

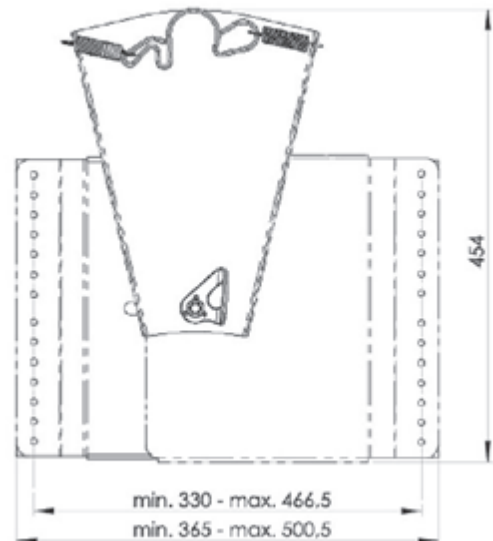

AT 182-01 + CR 200 + AZ 011

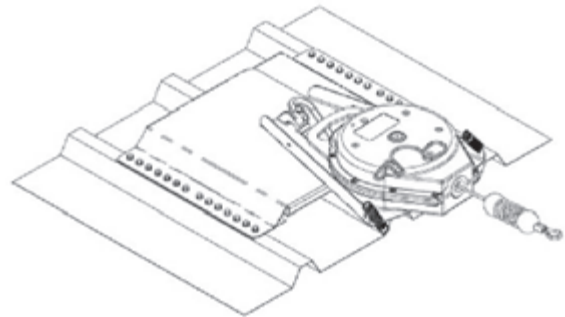

AT 182-2 **NEW** PERMANENT ANCHOR POINT

EN 795 A



Ref.: AT 182-2

Weight: 3,2kg

Material: stainless steel - AISI 304

Static strength: 15 kN

Fixing hole: 12,5 mm

Protection for one person.



Permanent anchor point

AT 150 PERMANENT ANCHOR POINT

EN 795 A



Ref.: AT 150

Dimensions: 135 x 60 x 60mm

Weight: 0,30kg

Material: Light alloy

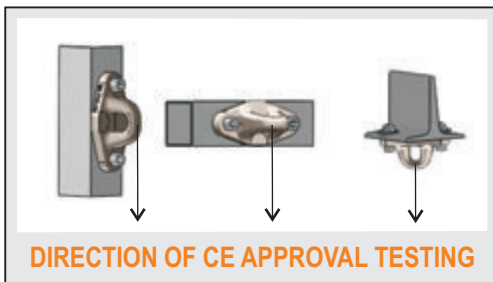

DIRECTION OF CE APPROVAL TESTING



AT 150 working with AZ 011



AT 150 working with AZ 002



AT 150 working with AZ 003

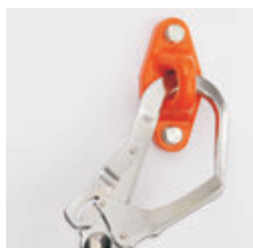

AT 150 working with AZ 022



AT 150

orange, yellow, silver - colours available now



other colours on request

PS 150 RUBBER PAD TO AT 150



Ref.: PS 150

Dimensions: 62 x 135 x 2,8mm

Weight: 19g

Material: Rubber EPDM

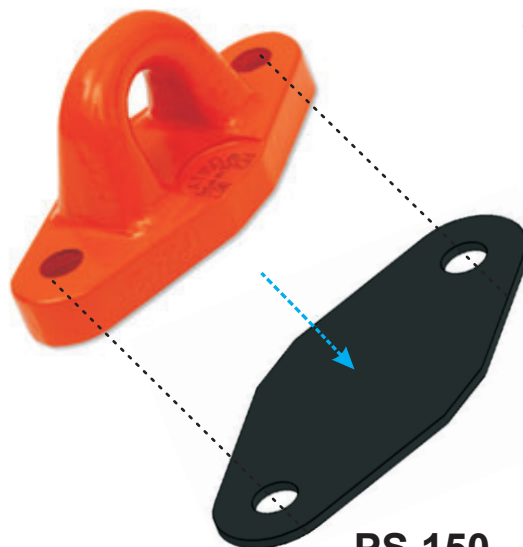

PS 150

Permanent anchor point

AT 180

PERMANENT ANCHOR POINT

EN 795 A



Ref.: AT 180

Dimensions: 56 x 56 x 50mm

Weight: 0,65kg

Material: stainless steel ANSI 316

Stud Anchor

HSA-R M12x120/25/4

Anchor length - 120mm

Edge distance - 90mm

Anchor type - mechanical anchor

Material - stainless steel

Standard embedment dept - 70 mm

Thread diameter - M12



AT 181

PERMANENT ANCHOR POINT

EN 795 A



Ref.: AT 181

Dimensions: 56 x 56 x 50mm

Weight: 0,65kg

Material: stainless steel ANSI 316

Stud Anchor

HSA-R M10x110/25/30

Anchor length - 110mm

Edge distance - 50mm

Anchor type - mechanical anchor

Material - stainless steel

Standard embedment dept - 50 mm

Thread diameter - M10

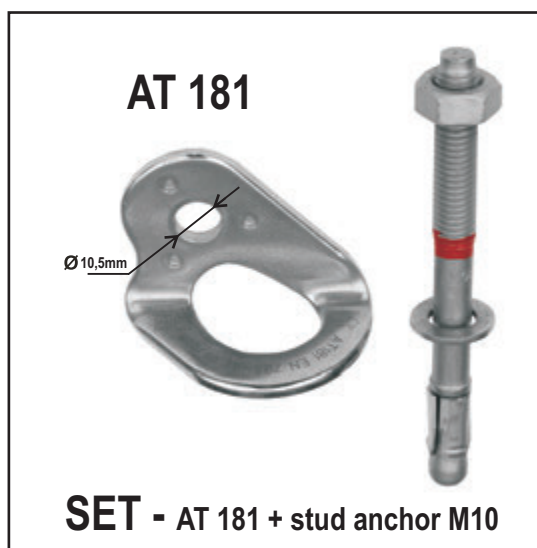

Permanent anchor point

AT 020 **NEW** PERMANENT ANCHOR POINT

EN 795 B



Ref.: AT 020

Weight: ~0,57kg

Material: galvanized steel, stainless steel, aluminium

Static strength: no less than 12kN

Protection for one person.

MONTAGE SEQUENCE

1. Squeeze device in the shown direction

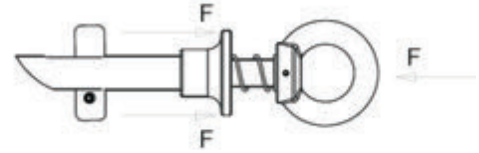

2. Apply device into prepared hole

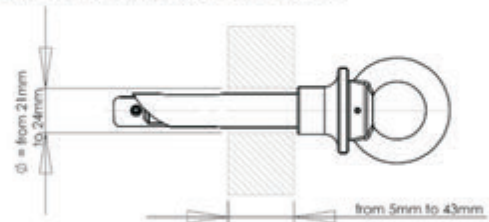

3. Make sure that cotter pin is open

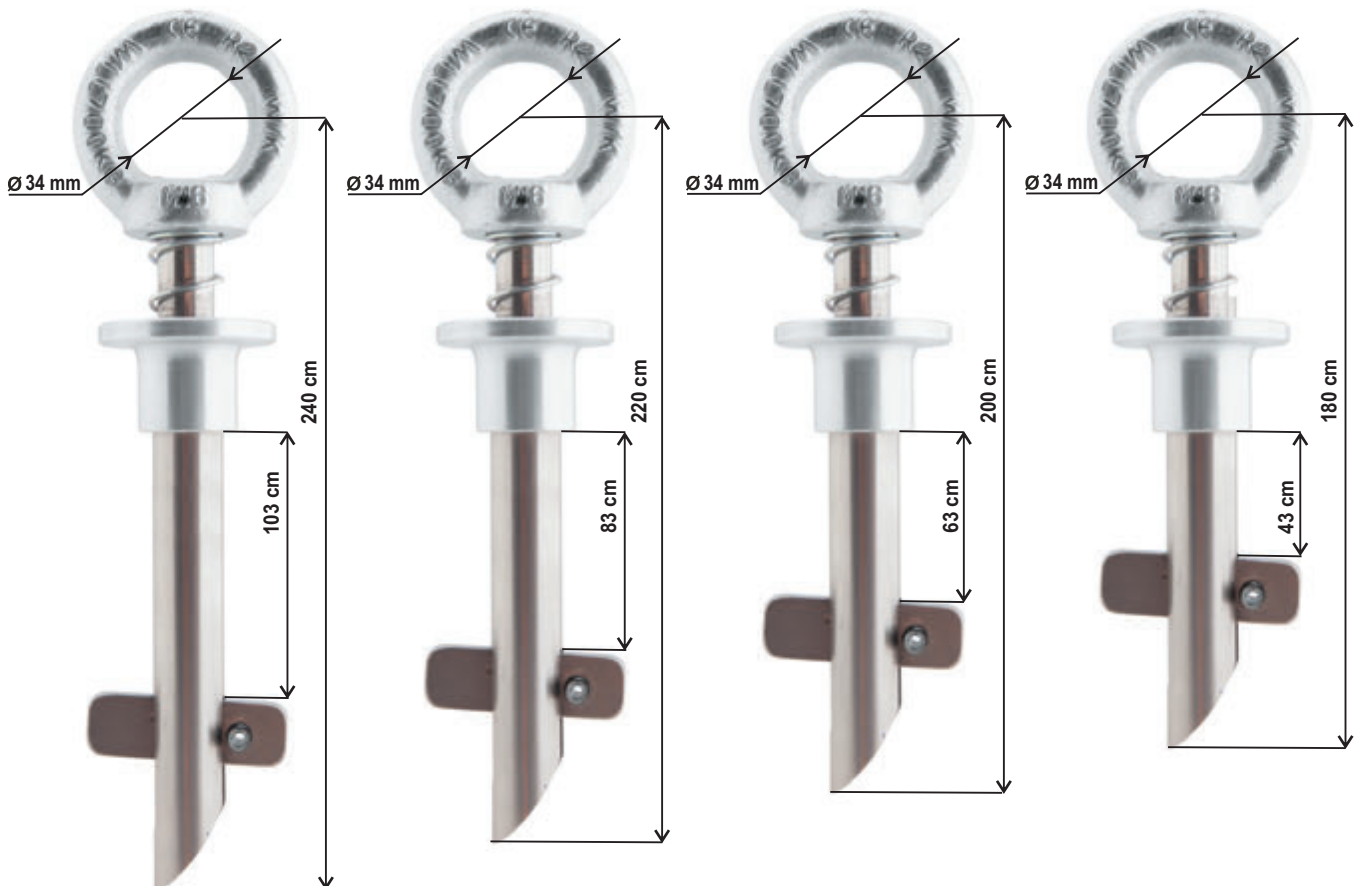
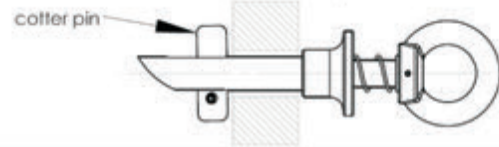

Permanent anchor point

AT 151 PERMANENT ANCHOR POINT

EN 795 A



Ref.: AT 151

Dimensions: 300 x 296 x 98 mm

Weight: 2,25kg

Material: stainless steel

Static strength: 10 kN

Protection for one person.



AT 152 PERMANENT ANCHOR POINT

EN 795 A



Ref.: AT 152

Dimensions: 173 x 60 x 20mm

Weight: 0,35kg

Material: hot-dip galvanized steel

Static strength: 12 kN

Protection for one person.



Permanent anchor point

AT 401 **NEW** PERMANENT ANCHOR POINT

EN 795 A



Ref.: AT 401

Dimensions: 418 x 195 mm

Weight: 0,54kg

Material: stainless steel

Static strength: 10 kN

Protection for one person.

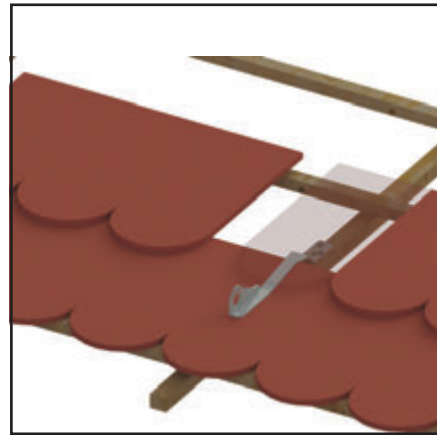

AT 402 **NEW** PERMANENT ANCHOR POINT

EN 795 A



Ref.: AT 402

Dimensions: 173 x 60 x 20mm

Weight: 0,35kg

Material: hot-dip galvanized steel

Static strength: 12 kN

Permissible static load: 2 kN

Protection for one person.

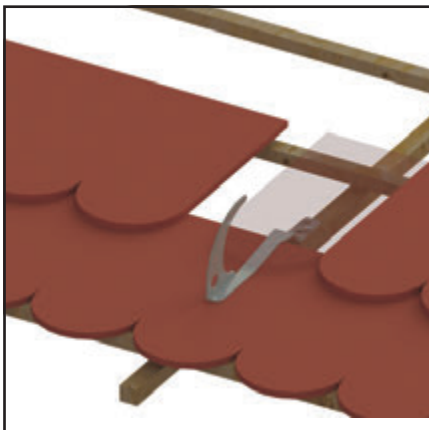

Permanent anchor point

AT 190 **NEW** PERMANENT ANCHOR POINT

EN 795 B



Ref.: AT 190

Material: stainless steel, copper

Static strength: 10 kN

Protection for one person.

AT 190 xx (xx - length)

Standards:

AT 190 060 - length 600 mm

AT 190 100 - length 1000 mm

AT 190 200 - length 2000 mm

AT 190 300 - length 3000 mm

AT 190 500 - length 5000 mm

AT 190 1000 - length 10 000 mm



↓ **F max: 10kN**

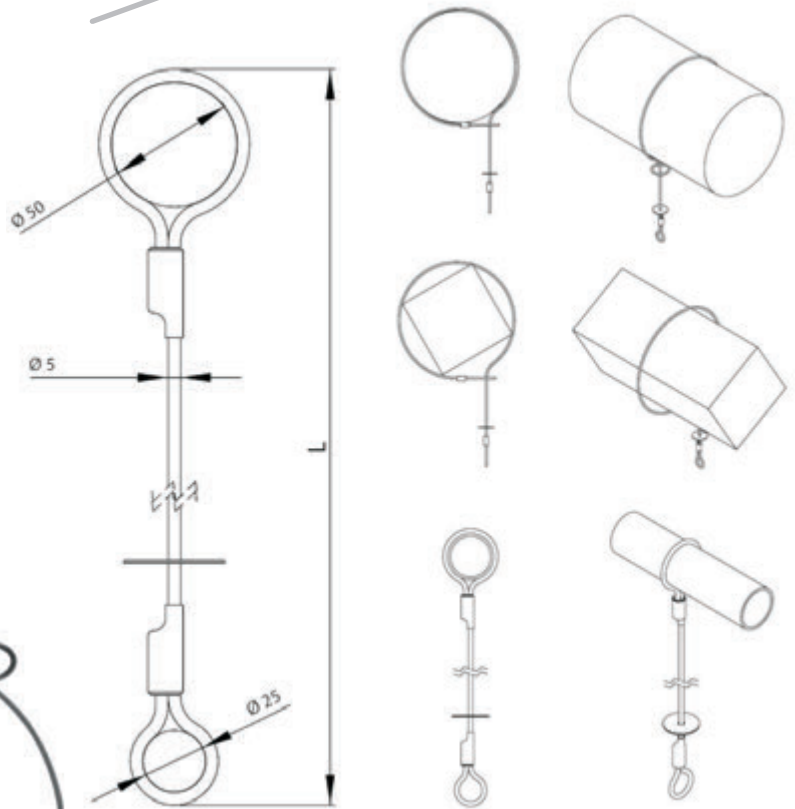

AT 191 **NEW** PERMANENT ANCHOR POINT

EN 795 B



Ref.: AT 191

Material: stainless steel, copper

Static strength: 30 kN

Protection for one person.

AT 191 xx (xx - length)

Standards:

AT 191 060 - length 600 mm

AT 191 100 - length 1000 mm

AT 191 200 - length 2000 mm

AT 191 300 - length 3000 mm

AT 191 500 - length 5000 mm

AT 191 1000 - length 10 000 mm

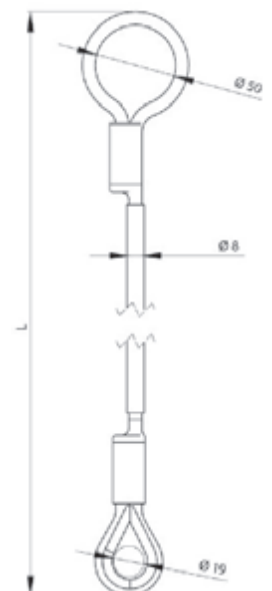

Cable clamp

AT 191s CABLE CLAMP FOR TELESCOPIC POLE **NEW**

EN 795 B



Ref.: AT 191s

Material: stainless steel, copper, polyamide

Static strength: 30 kN

Protection for one person.

AT 191s xx (xx - length)

Standards:

AT 191s 060 - length 60 cm

AT 191s 100 - length 100 cm

AT 191s 200 - length 200 cm

AT 191s 300 - length 300 cm

AT 191s 500 - length 500 cm

AT 191s 1000 - length 1000 cm

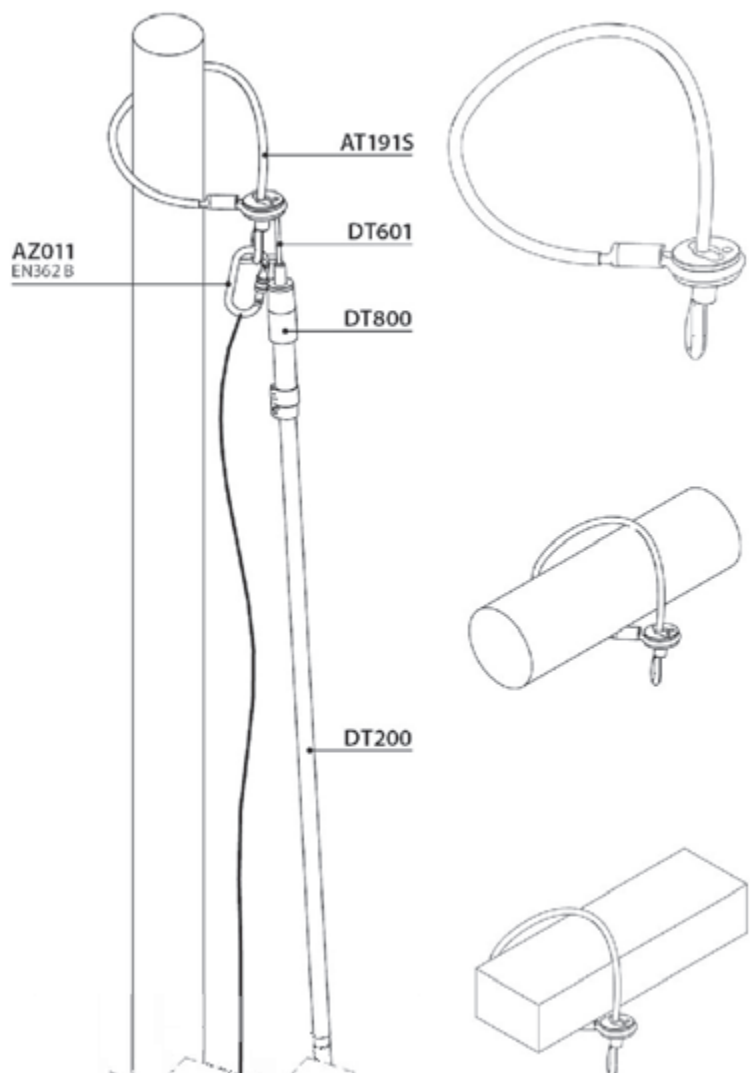
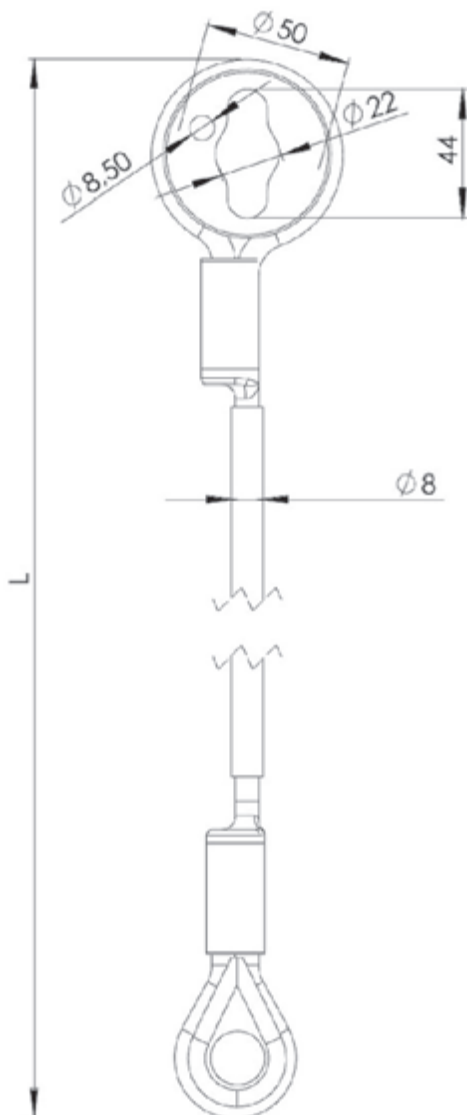

Permanent anchor point

AT 192 **NEW** PERMANENT ANCHOR POINT

EN 795 A2



Ref.: AT 192

Material: stainless steel, galvanized steel

Static strength: 12 kN

Protection for one person.

AT 192 xx (xx - length)

Standards:

AT 192 035 - length 350 mm

AT 192 100 - length 1000 mm

AT 192 200 - length 2000 mm

AT 192 300 - length 3000 mm

AT 192 400 - length 4000 mm

AT 192 500 - length 5000 mm

AT 192 XX 001 - SET

ASSEMBLY FOR THE TIMBER

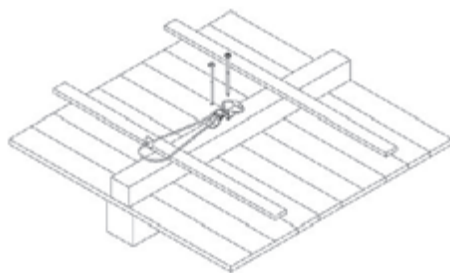

+



AT 192 035 001 - length 350 mm

AT 192 100 001 - length 1000 mm

AT 192 200 001 - length 2000 mm

AT 192 300 001 - length 3000 mm

AT 192 400 001 - length 4000 mm

AT 192 500 001 - length 5000 mm

AT 192 XX 002 - SET

ASSEMBLY OF THE STEEL PROFILE

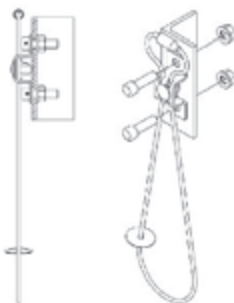

+



AT 192 035 002 - length 350 mm

AT 192 100 002 - length 1000 mm

AT 192 200 002 - length 2000 mm

AT 192 300 002 - length 3000 mm

AT 192 400 002 - length 4000 mm

AT 192 500 002 - length 5000 mm

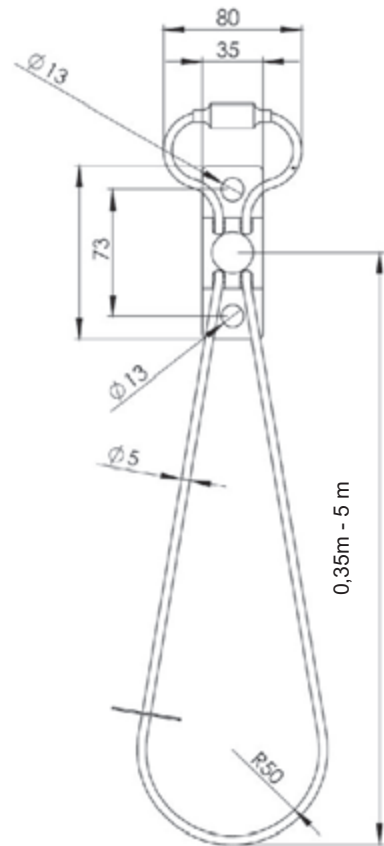

Permanent anchor point

HL 104 **NEW** PERMANENT ANCHOR POINT

EN 795 A



Ref.: HL 104

Dimensions: 70 x 166 x 39 mm
Material: stainless steel - AISI 304
Static strength: 12 kN
Protection for one person.

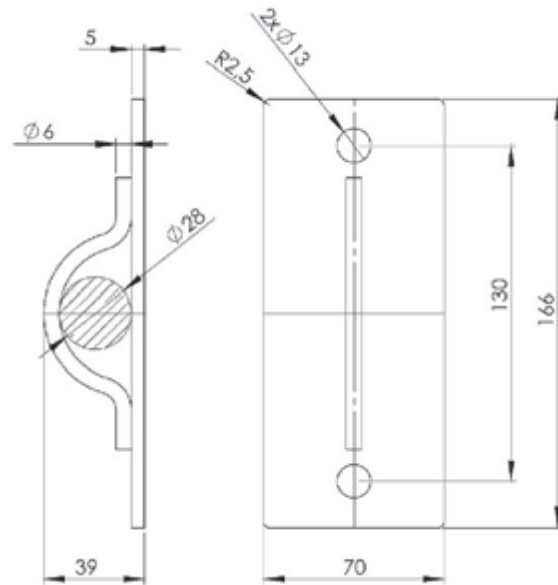

HL 104 001 - SET

ASSEMBLY FOR CONCRETE

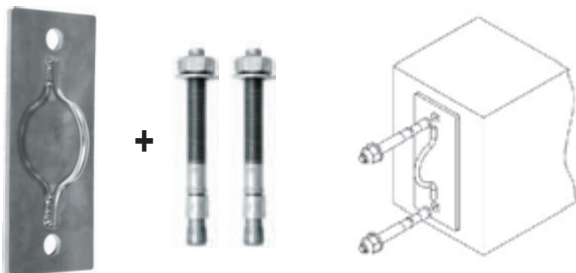

HL 104 + the anchor of stainless steel M12.

HL 104 002 - SET

ASSEMBLY FOR CONCRETE

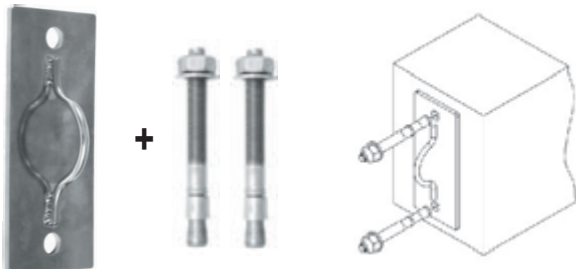

HL 104 + the anchor made of galvanized steel M12.

HL 104 003 - SET

ASSEMBLY OF THE STEEL PROFILE

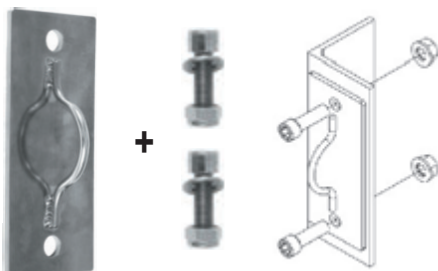

HL 104 + the anchor of stainless steel M12.

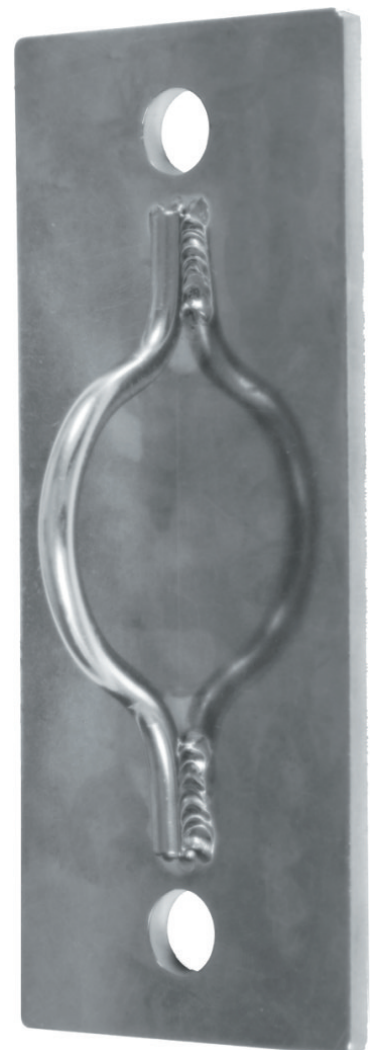

Permanent anchor point

Permanent anchor point

HL 105 **NEW** PERMANENT ANCHOR POINT

EN 795 A



Ref.: HL 105

Dimensions: 130 x130 x 17-66,5 mm

Material: Powder coated steel - RAL 1023

Static strength: 12 kN

Protection for one person.

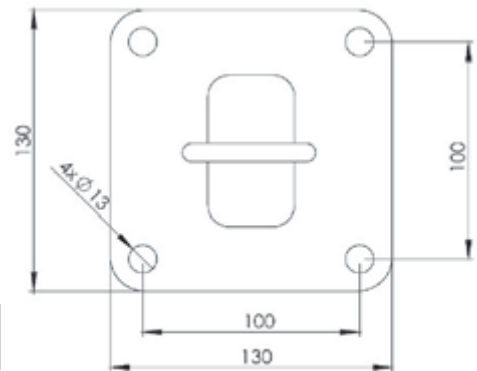
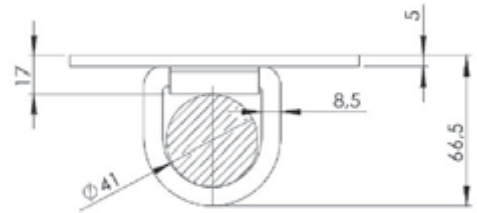

HL 105 001 - SET

ASSEMBLY FOR CONCRETE



HL 104 + the anchor of stainless steel M12.

HL 105 002 - SET

ASSEMBLY FOR CONCRETE



HL 104 + the anchor made of galvanized steel M12.

HL 105 003 - SET

ASSEMBLY OF THE STEEL PROFILE

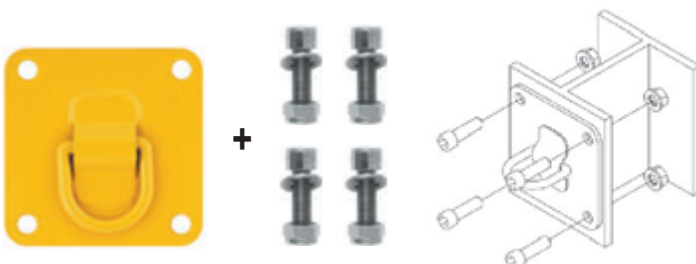

HL 104 + the anchor of stainless steel M12.



Permanent anchor point

AC 340 ANCHOR CLAMP

EN 795 A



Ref.: AC 340

Weight: 2,5 kg;
Material: stainless steel - 6 mm;
System strength > 10kN
Clamping range: 75-140 mm

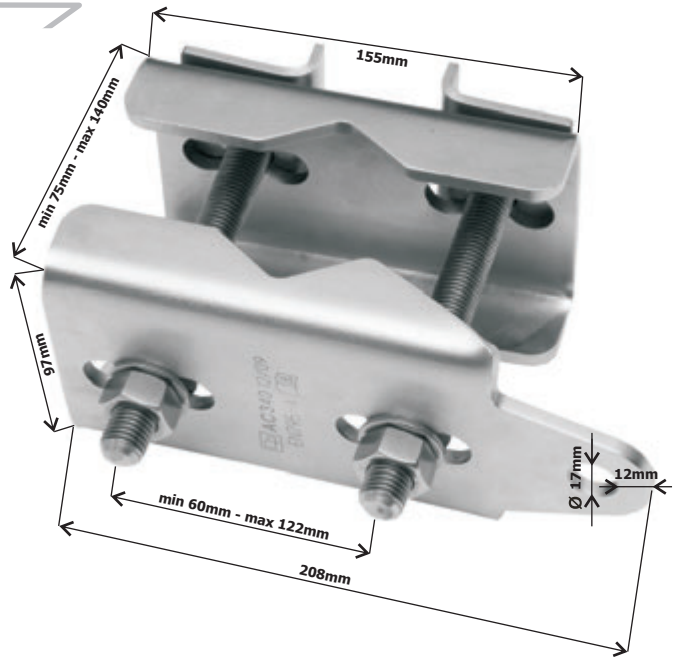

USE OF THE DEVICE

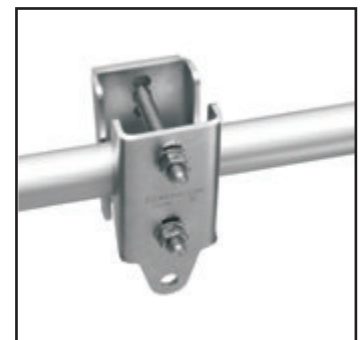
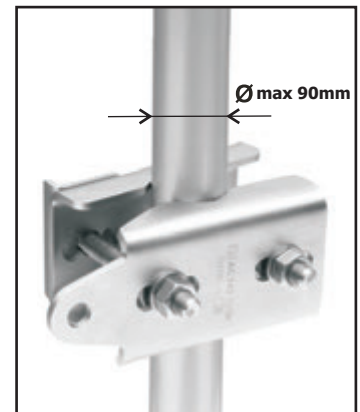
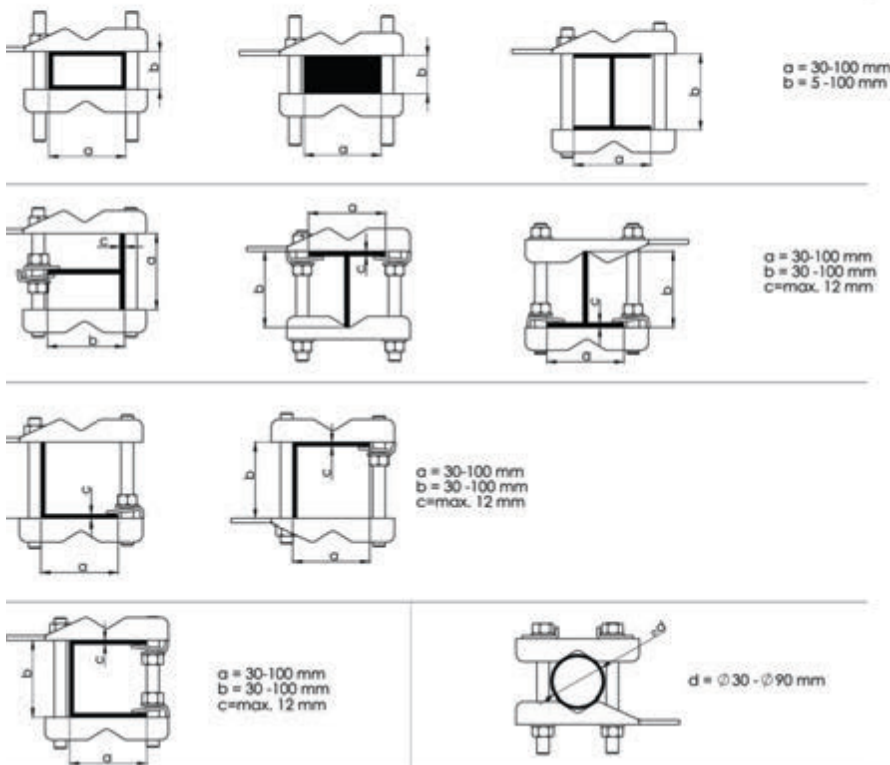

MONTAGE

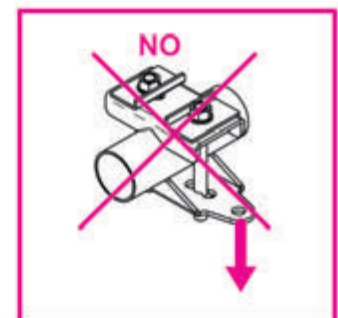
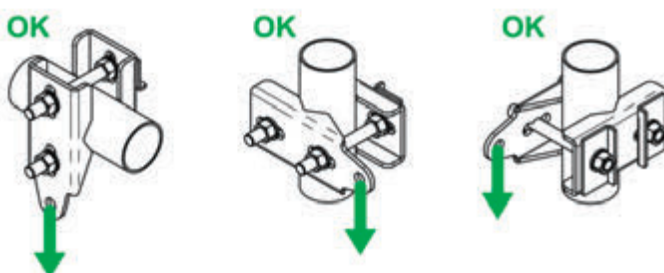

Permanent horizontal systems

ST 010 ANCHOR TROLLEY

EN 795 B



Ref.: AT 100

Can be used with rails - width **65 - 120 mm**;

Weight: 5,2 kg;

Material: galvanized steel, painted steel



EXAMPLE: ST 010 with CR 200

ST 020 ANCHOR CLAMP

EN 795 B



Ref.: AT 200

Can be used with rails - width **75 - 210 mm**;

Weight: 4,0 kg;

Material: galvanized steel, painted steel

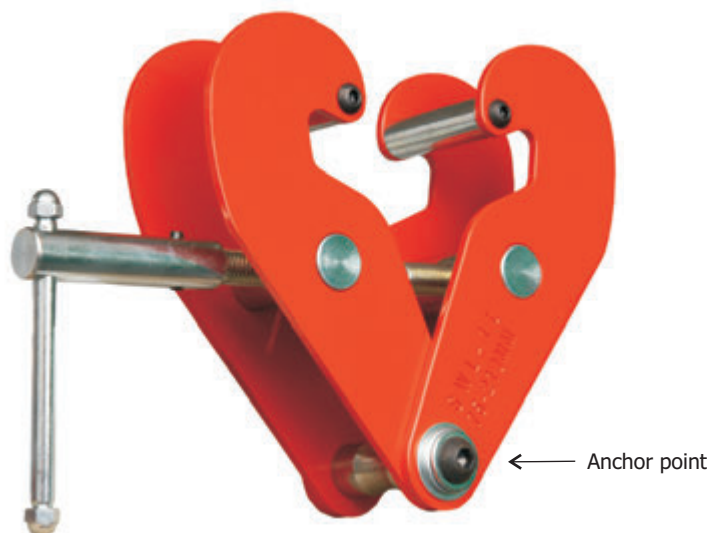

Permanent horizontal systems

AT 250 **ALU ANCHOR CLAMP**

EN 795 B



Ref.: AT 250

Dimensions: 440 x 100 x 45 mm;

Weight: 1,37 kg;

Material: alu.

For one worker.

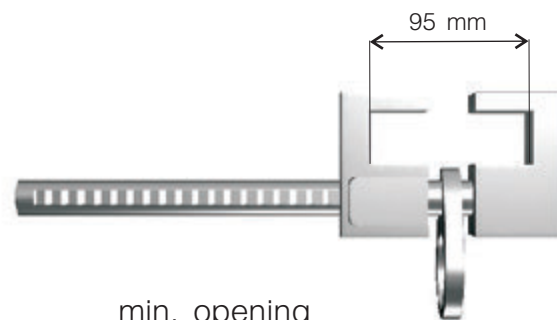
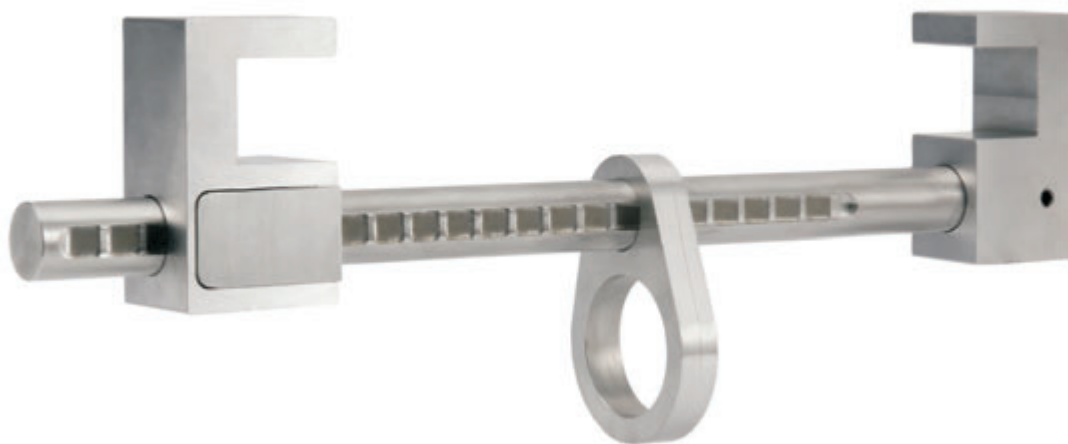

min. opening

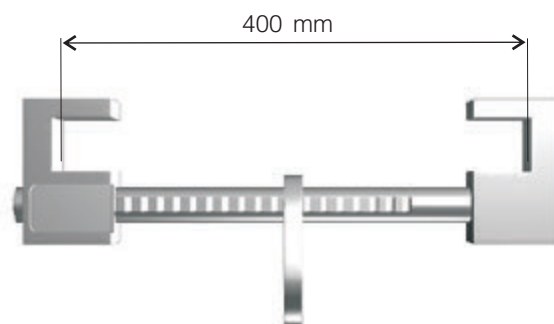

max. opening

Tripods, anchor and rescue

TM-9 SAFETY TRIPOD

EN 795 class B



Ref.: AT 011

working load limit 500kg

breaking force: 22kN

version with webbing or chain

weight: 14,30kg - with webbing

17,30kg - with chain

We deliver tripod with chain and webbing.

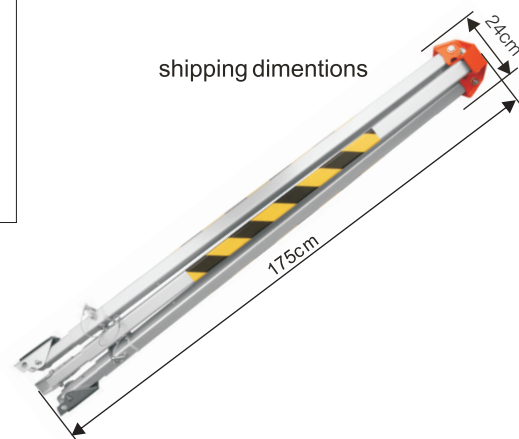
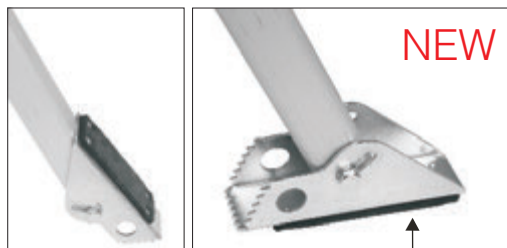
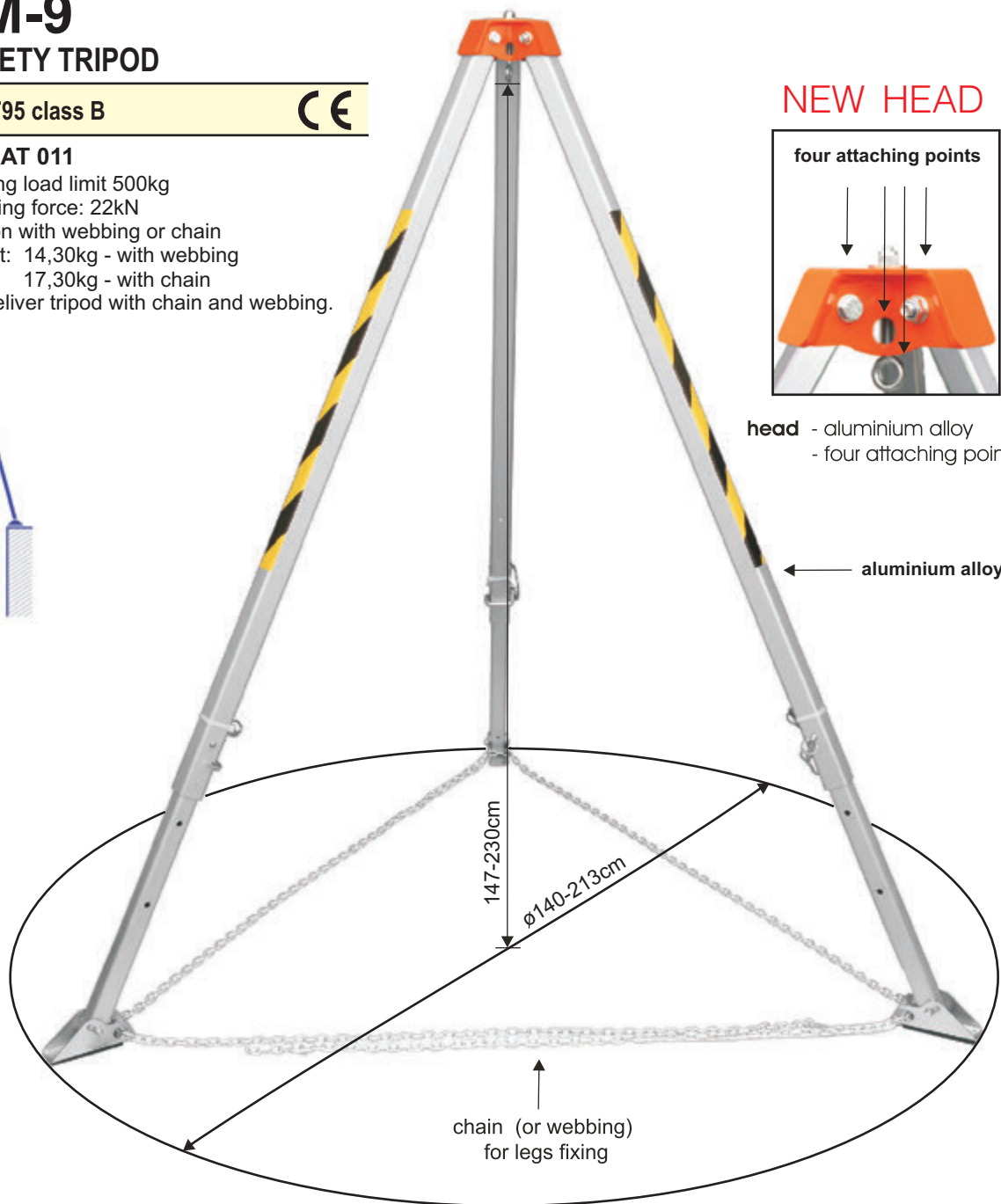

Tripods, anchor and rescue

TM-11

SAFETY TRIPOD

NEW

EN 795 class B



Ref.: AT 013

RANGES:

Legs fully retracted ... extended)

Working Height: 179 - 290cm

Legs Spacing: 147 - 232cm

Diameter over which can deploy a tripod: 173 - 271 cm

PARAMETERS:

Working load limit: 1000 kg.

- aluminium alloy legs,
- additional steps (3 pcs.)
- weight: 43 kg.

Safety tripod TM-11 is a component of personal protective equipment against falls from a height. It is used as a portable anchor point.

Safety tripod TM-11 has been tested according to EN 795 as a transportable temporary anchorage devices class B.

Tripod TM-11 has to be used in conjunction with fall arrest equipment.

Telescopic legs allow to adjust tripod's height.

Tripod TM-11 can be the protection for one person only.

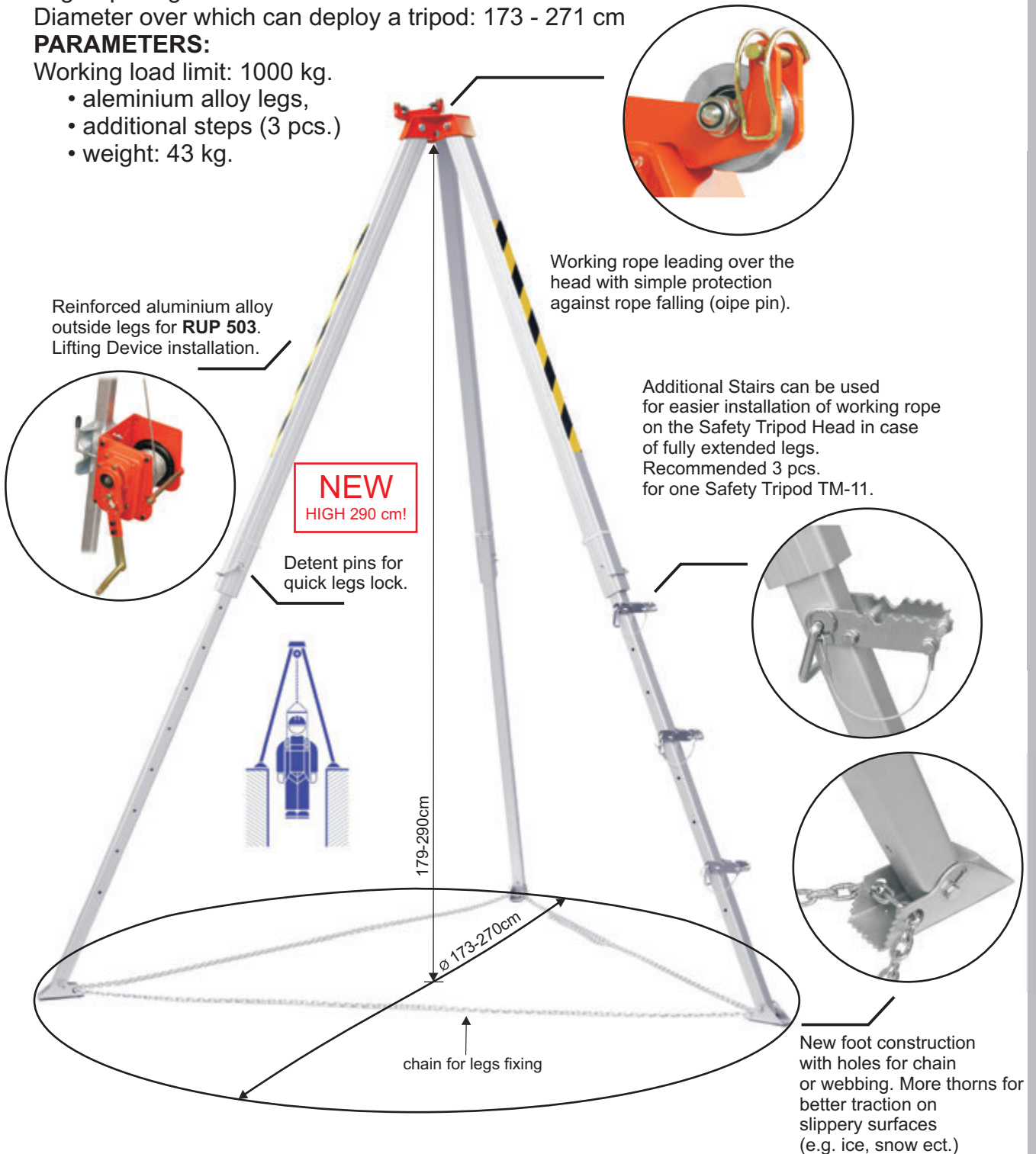

Tripods, anchor and rescue

RUP-503

LIFTIG DEVICE

Ref.: AT 053 25 - 25 m cable

Ref.: AT 053 35 - 35 m cable

Ref.: AT 053 45 - 45 m cable

Ref.: AT 053 50 - 50 m cable

Lifting and lowering device:

- Automatic brake
- Capacity: 1000 kg
- Hand force required: 10 kg
- Weight: 22,5 kg (25 m cable)
24,0 kg (35 m cable)
25,5 kg (45 m cable)

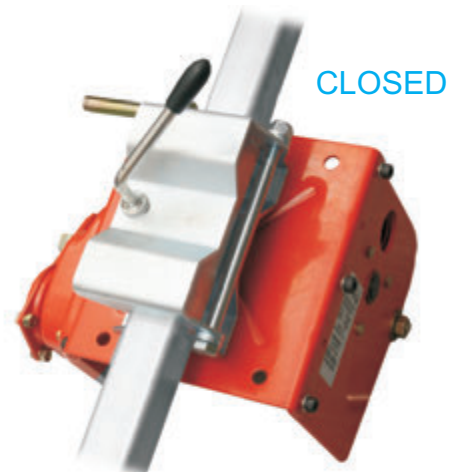
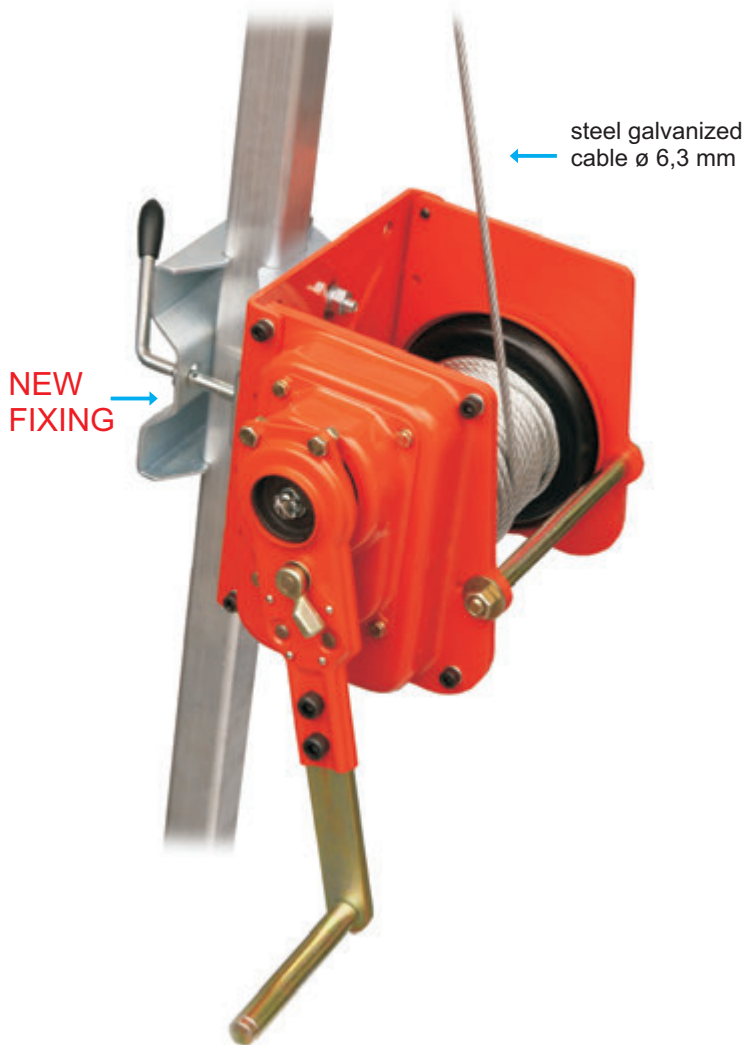

Tripods, anchor and rescue

RUP-502

RESCUE LIFTIG DEVICE

EN 1496 class B

Ref.: AT 050 20 - 20 m cable

Ref.: AT 050 25 - 25 m cable

Rescue lifting and lowering device:

- Automatic brake
- Weight: 13-14 kg
- Working load: 140 kg

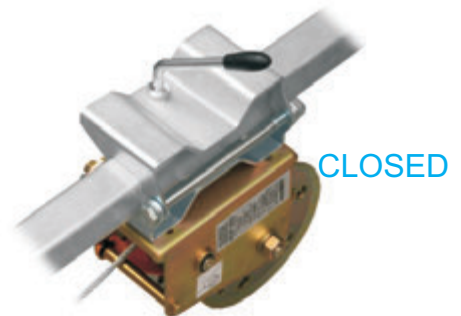
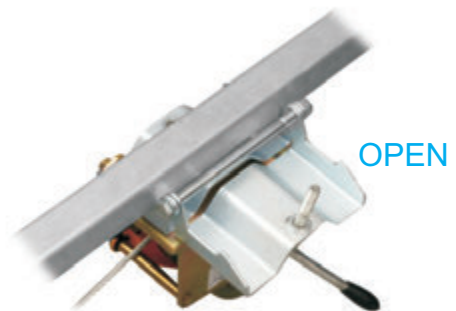
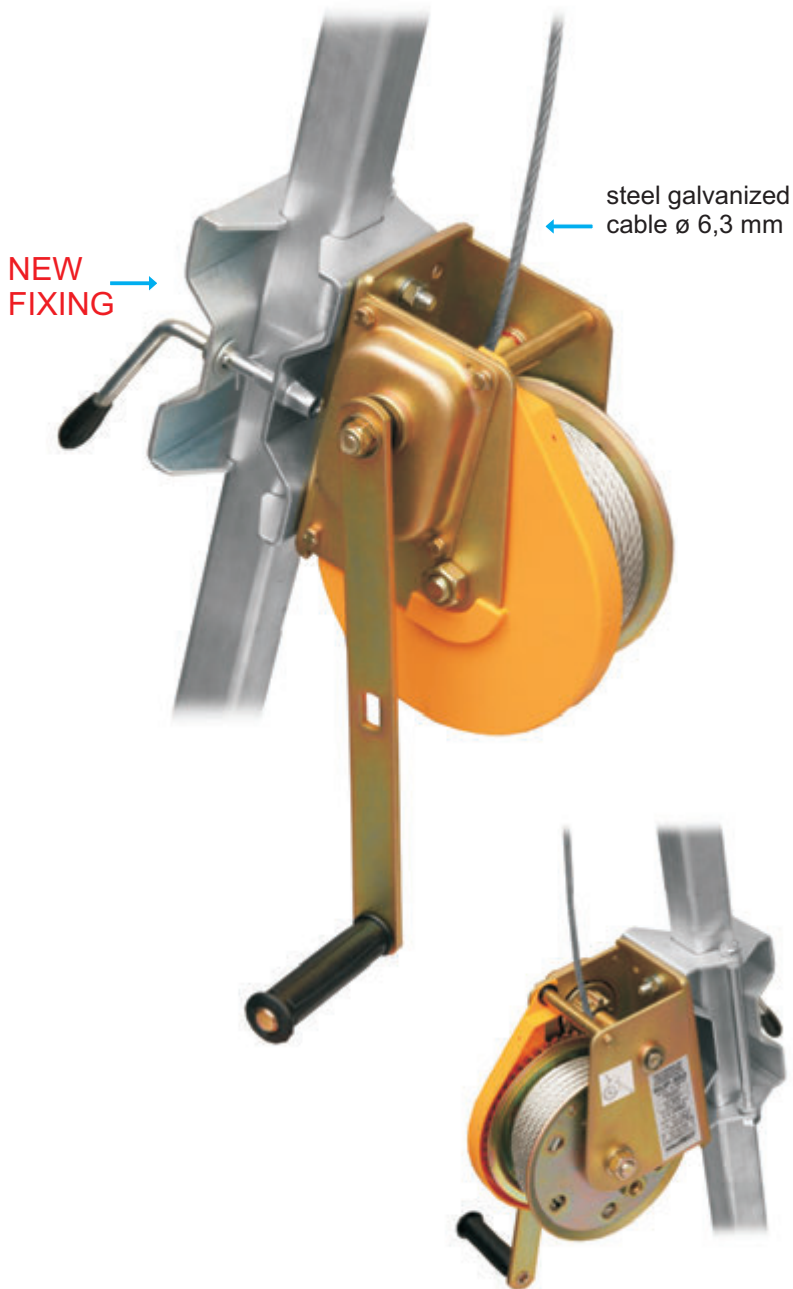

AT 300

RESCUE LIFTIG SLING

EN 354 EN 358



Ref.: AT 300 01 - without snap hooks

Ref.: AT 300 02 - with snap hooks AZ 011

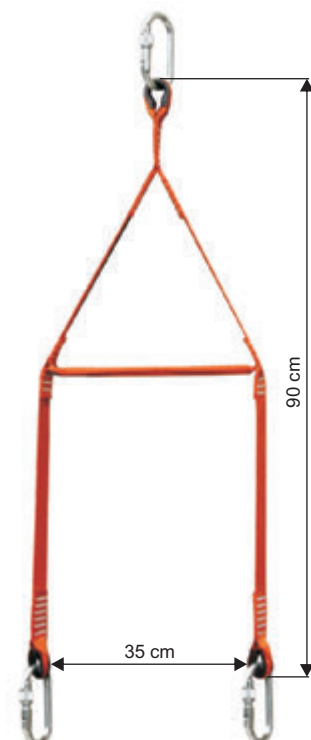

Tripods, anchor and rescue

PL 101

PULLEY

To Rescue Lifting Device RUP-502,
and Safety Tripod TM-9

Ref.: PL 101

Dimensions: 133 x 56 x 128 mm

Weight: 450g

Material: galvanized steel, composite

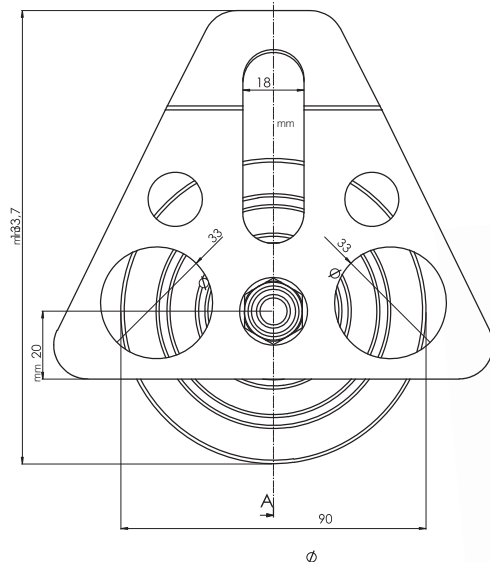
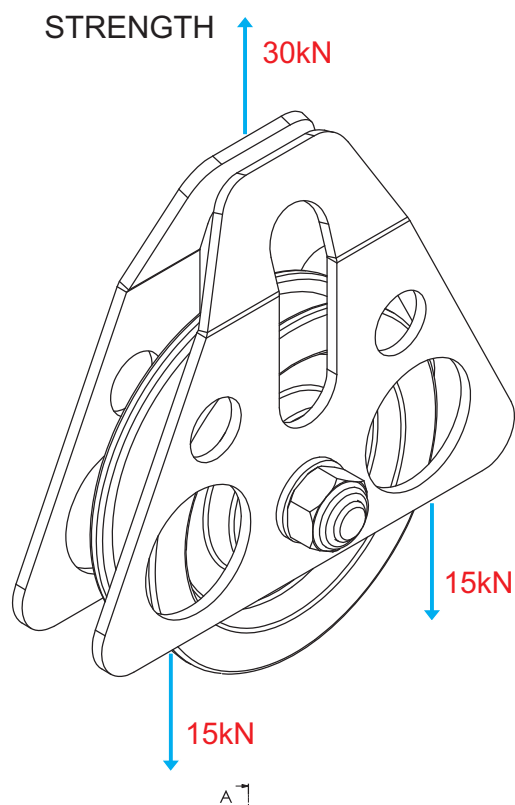

AZ 090 →

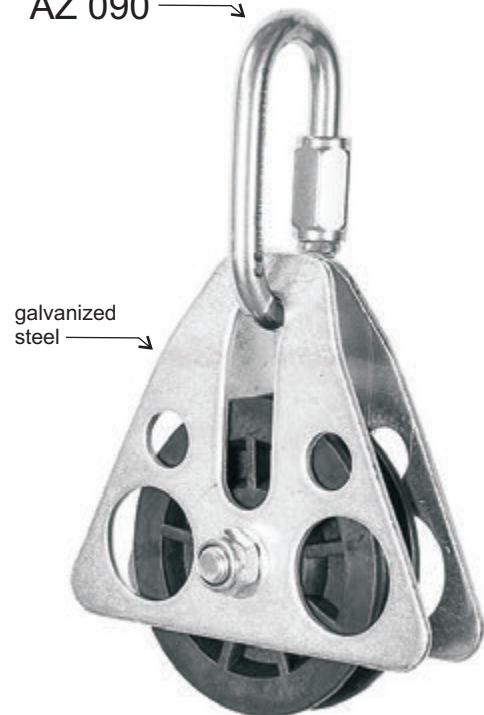

← polyamide reinforced glassfibre



Tripods, anchor and rescue

TU 415

Pulley with hook 1000kg

Ref.: PL 415

TU 415 is used for lifting and lowering loads up to 1000kg.

Material: Galvanized steel / stainless steel / radilon (pulley)

Weight: 1,14kg

Dimensions: 300x130x56mm

WWL (Working Load Limit): 10kN

MBS (Minimum Braking Force): 40kN

Safety Factor: 4:1



TU 416

Pulley with hook 2000kg

Ref.: PL 416

TU 416 is used for lifting and lowering loads up to 2000kg.

Material: Galvanized steel / stainless steel / cast (pulley)

Weight: 2,54kg

Dimensions: 330x130x56mm

WWL (Working Load Limit): 20kN

MBS (Minimum Braking Force): 60kN

Safety Factor: 3:1



Tripods, anchor and rescue

AT 060 ANCHOR BEAM

EN 795 Class B



Ref.: AT 060

Dimensions: 1415 x 150 x 100 mm;
Weight: 6,9 kg;
Material: galvanized steel.
For one worker.

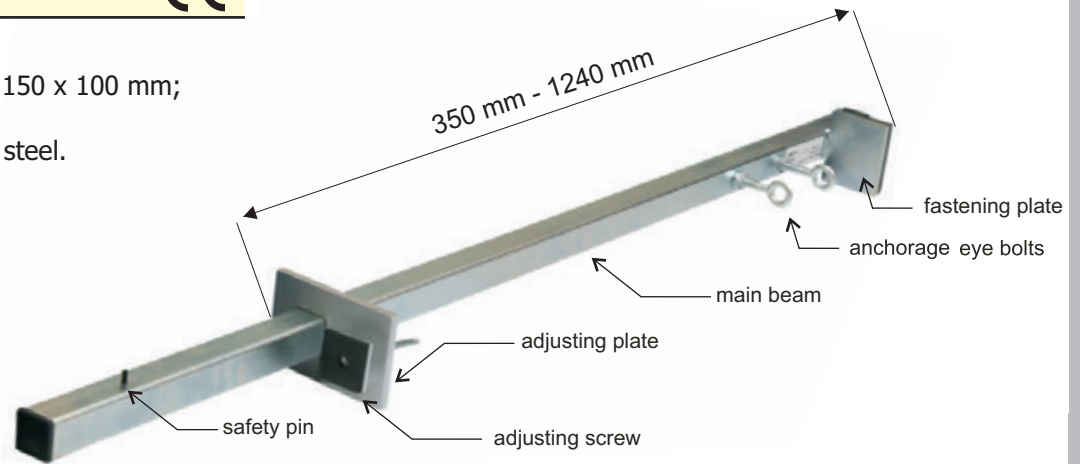

AT 061 ALU ANCHOR BEAM + BAG

EN 795 Class B



Ref.: AT 061

Dimensions: 1450 x 122 x 100 mm;
Weight: 3,2 kg;
Material: alu.
For one worker.

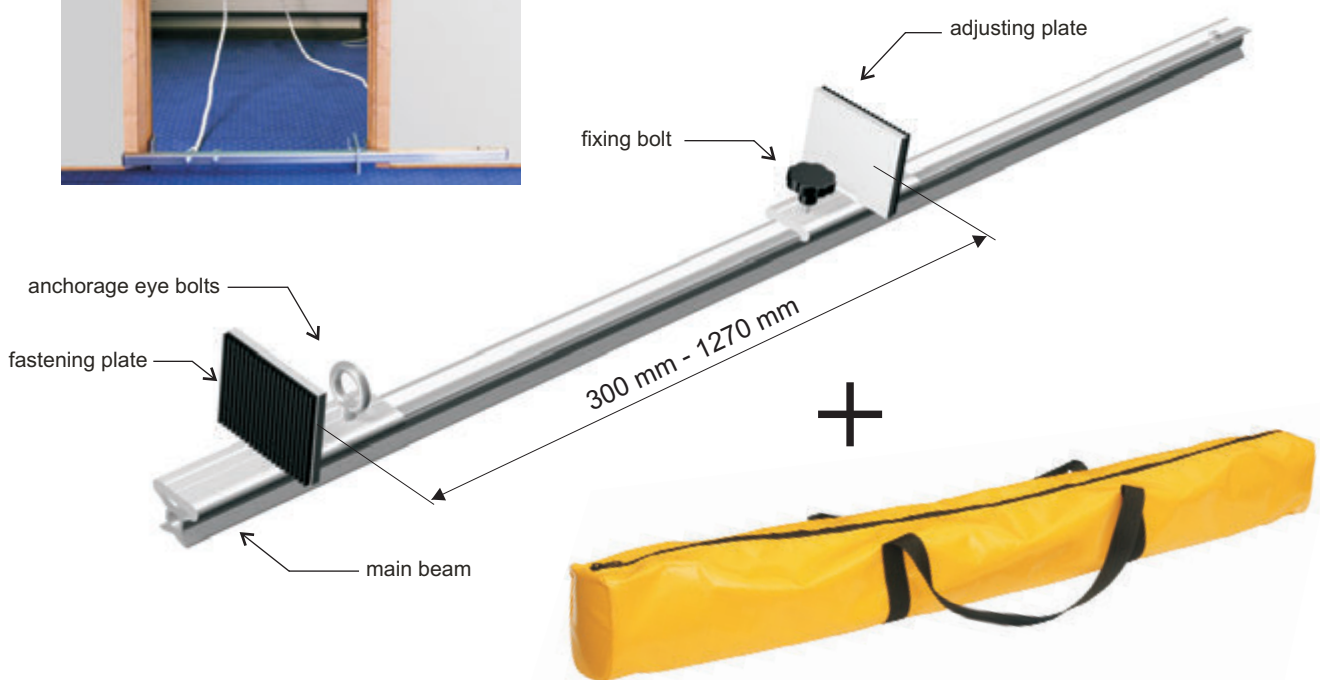

Tripods, anchor and rescue

AT 062 set

ALU ANCHOR BEAM AT 061 + AT 061A + BAG

EN 795 Class B



Ref.: AT 062

Dimensions after packing:

1450 x 300 x 200mm

Weight: 6,7kg (with bag);

Material: alu profiles

For one worker.

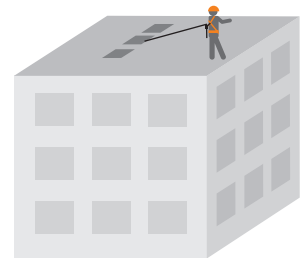
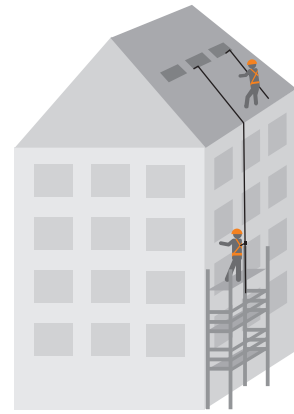

AT 061A - removable, adjustable secure clamp
for alu anchor beam AT 061

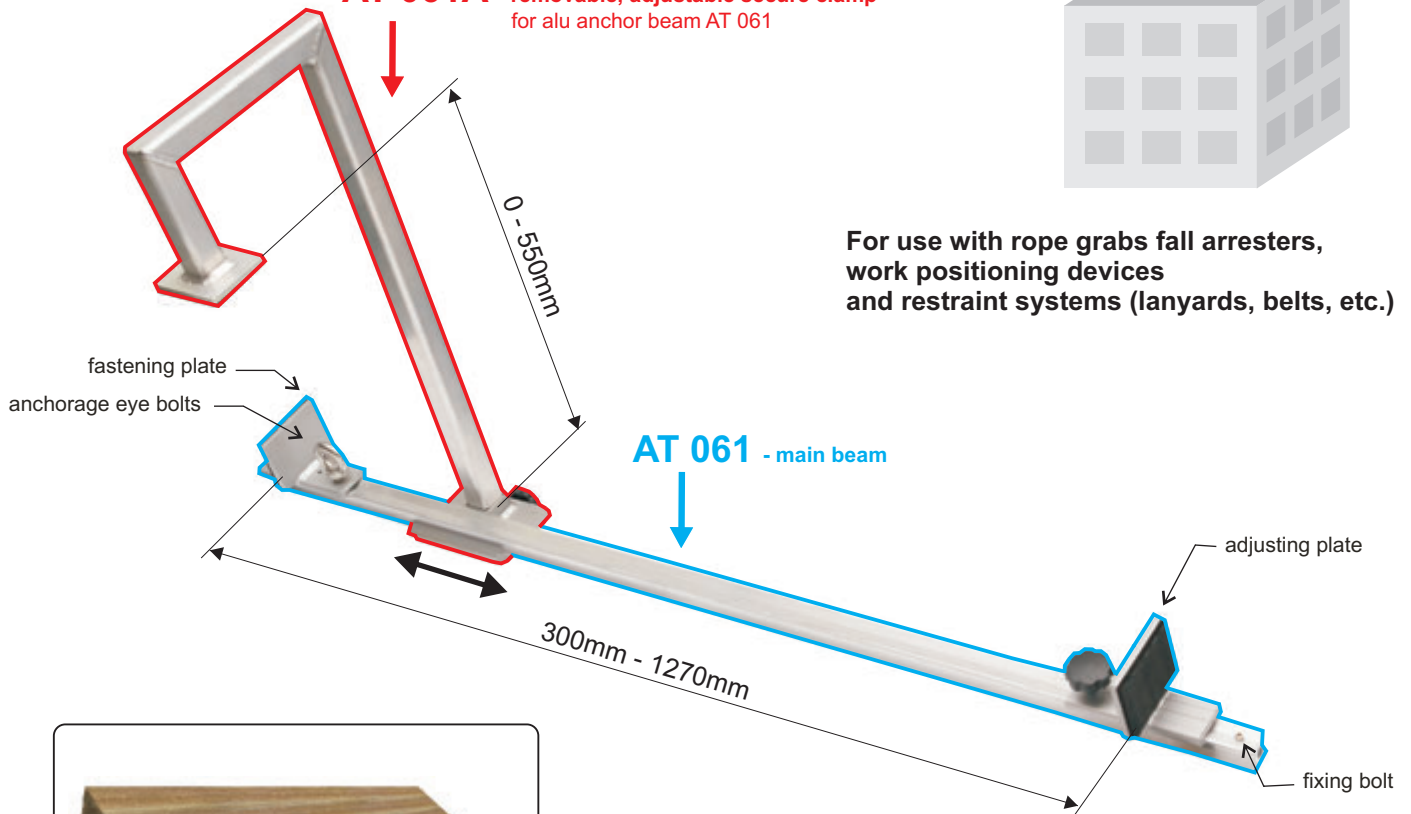

For use with rope grabs fall arresters,
work positioning devices
and restraint systems (lanyards, belts, etc.)

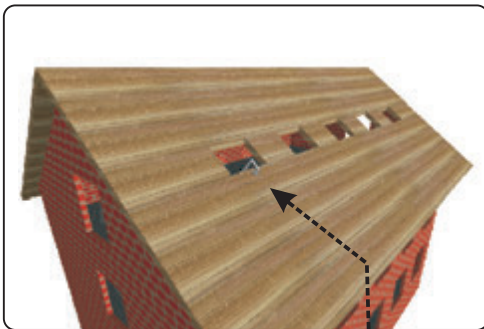

Tripods, anchor and rescue

AR 010 RESCUE DESCENT DEVICES

EN 341 Class C

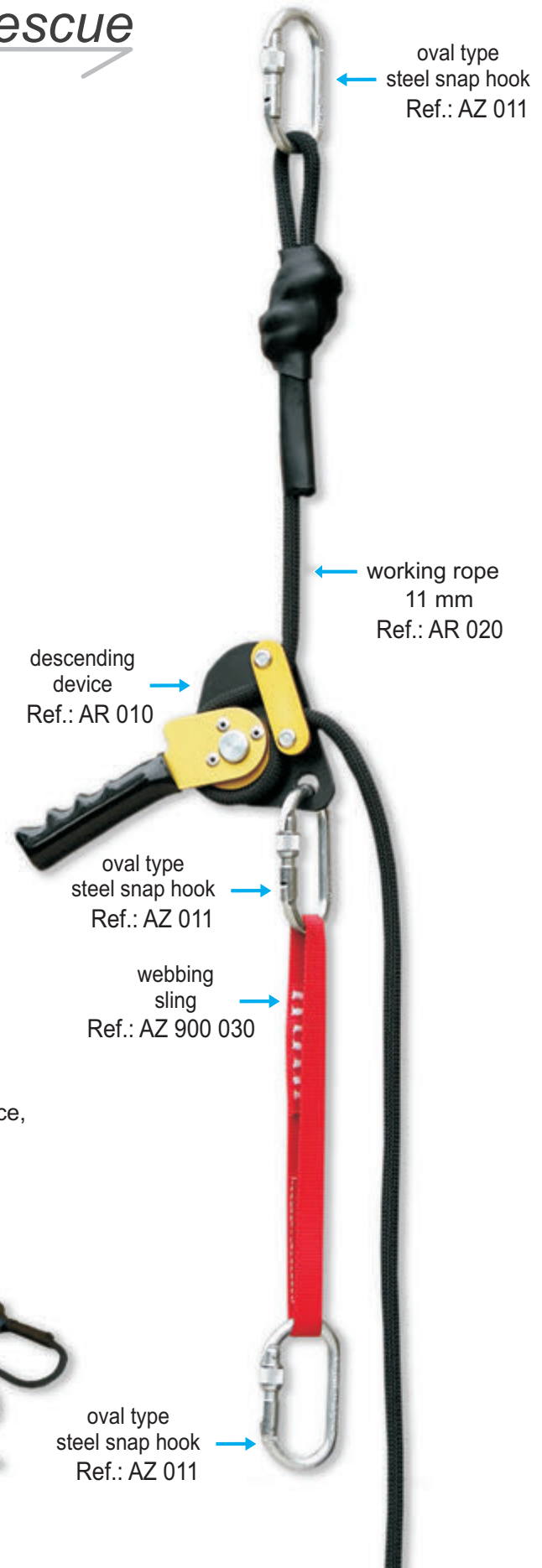

ESCAPE KIT:

- descending device,
- working rope,
- 3 snap hooks,
- webbing sling,
- knife,
- transporting bag.



KITS WITH ROPE: 20m
30m
40m
50m

Tripods, anchor and rescue



DX 301 rescue triangle

Ref.: DX 301



P-10R safety harness

EN 361 EN 1497



Ref.: AB 110 03

Harness with front and dorsal anchorage point.

Rescue anchorage point

Size: M-XL - 1460g

XXL - 1600g

Separate regulation for legs and shoulders straps.

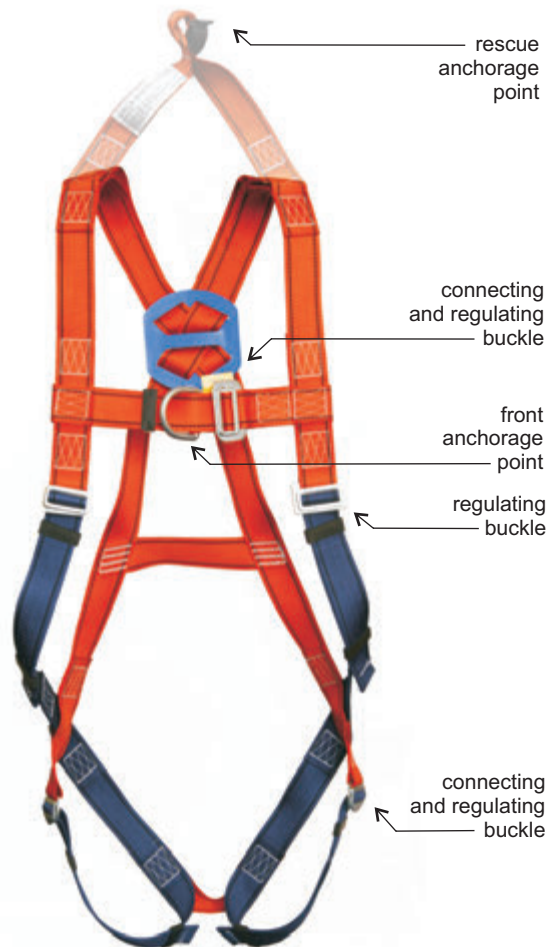
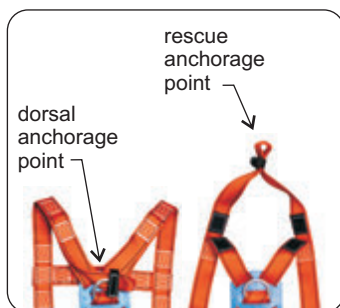

Steel snap hooks



AZ 011 SCREW SNAP HOOK

EN 362

Ref.: AZ 011
Weight: 180 g
Dimensions: 108 x 60 mm
ZINC PLATED STEEL

OPENING Ø18mm



AZ 011T "TWIST LOCK"

EN 362

Ref.: AZ 011T

OPENING Ø18mm



AZ 017 SCREW SNAP HOOK

EN 362

Ref.: AZ 017
Weight: 200 g
Dimensions: 113 x 71 mm
ZINC PLATED STEEL

OPENING Ø25mm



AZ 017T "TWIST LOCK"

EN 362

Ref.: AZ 017T

OPENING Ø25mm



AZ 018 SCREW SNAP HOOK

EN 362

Ref.: AZ 018
Weight: 220 g
Dimensions: 125 x 80 mm
ZINC PLATED STEEL

OPENING Ø27mm



AZ 018T "TWIST LOCK"

EN 362

Ref.: AZ 018T

OPENING Ø27mm

Alu snap hooks



OPENING Ø18mm

AZ 012 SCREW SNAP HOOK

EN 362

Ref.: AZ 012
Weight: 80 g
Dimensions: 111 x 64 mm
LIGHT ALLOY



OPENING Ø18mm

AZ 012T "TWIST LOCK"

EN 362

Ref.: AZ 012T
Weight: 90 g
Dimensions: 111 x 64 mm
LIGHT ALLOY



OPENING Ø24mm

AZ 014 SCREW SNAP HOOK

EN 362

Ref.: AZ 014
Weight: 80 g
Dimensions: 115 x 74 mm
LIGHT ALLOY



OPENING Ø24mm

AZ 014T "TWIST LOCK"

EN 362

Ref.: AZ 014T
Weight: 80 g
Dimensions: 115 x 74 mm
LIGHT ALLOY



OPENING Ø45mm

AZ 111 "TWIST LOCK"

EN 362

Ref.: AZ 111
Weight: 220 g
Dimensions: 196 x 111 mm
LIGHT ALLOY



OPENING Ø45mm

AZ 111B "TWIST LOCK"

EN 362

Ref.: AZ 111B

Snap hooks

AZ 023

DOUBLE FINGER LOCKING TYPE SNAP HOOK

EN 362



Ref.: AZ 023

Weight: 460 g
Dimensions: 240 x 130 mm
LIGHT ALLOY



OPENING Ø60mm

AZ 024

DOUBLE FINGER LOCKING TYPE SNAP HOOK

EN 362



Ref.: AZ 024

Weight: 900 g
Dimensions: 360 x 190 mm
LIGHT ALLOY



OPENING Ø100mm

AZ 014DT

"TWIST LOCK"

NEW!

EN 362



Ref.: AZ 014DT

Weight: 80 g
Dimensions: 115 x 74 mm
LIGHT ALLOY



OPENING Ø22mm

AZ 022

DOUBLE FINGER LOCKING TYPE SNAP HOOK

EN 362



Ref.: AZ 022

Weight: 500 g
Dimensions: 220 x 120 mm
ZINC PLATED STEEL

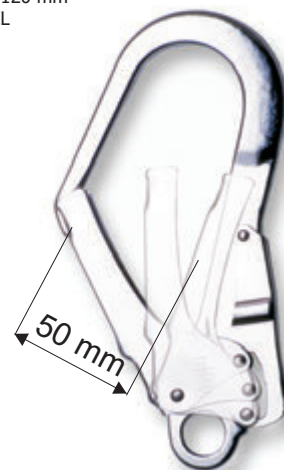

OPENING Ø50mm

Snap hooks

AZ 025

DOUBLE FINGER LOCKING TYPE SNAP HOOK

EN 362



Ref.: AZ 025

Weight: 820 g
Dimensions: 330 x 155 mm
Opening: 83 mm
ZINC PLATED STEEL



OPENING Ø83mm

AZ 125

DOUBLE FINGER LOCKING TYPE SNAP HOOK

EN 362



Ref.: AZ 125

Weight: 460 g
Dimensions: 340 x 160 mm
Opening: 90 mm
LIGHT ALLOY



OPENING Ø90mm

AZ 122

DOUBLE FINGER LOCKING TYPE SNAP HOOK

EN 362



Ref.: AZ 122

Weight: 350 g
Dimensions: 260 x 140 mm
LIGHT ALLOY



OPENING Ø65mm

AZ 019T

"TWIST LOCK"

NEW!

EN 362



Ref.: AZ 019T

Weight: 80 g
Dimensions: 119 x 75 mm
LIGHT ALLOY



OPENING Ø27mm

Trauma straps

AY 201 trauma strap

Ref.: AY 201

Working length: 120 cm

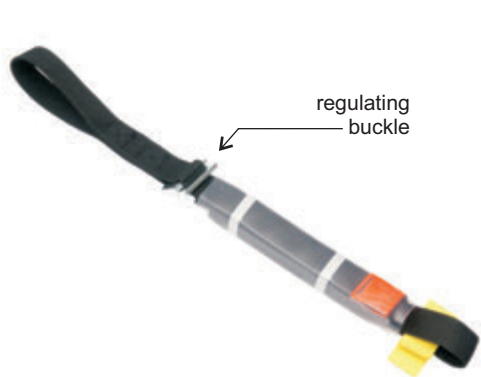

AY 202 trauma strap

Ref.: AY 202

Working length: 105 cm

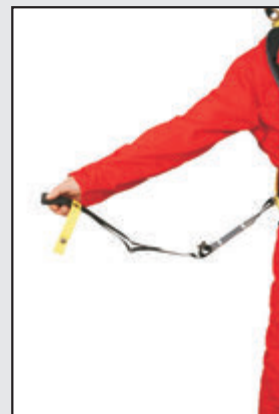
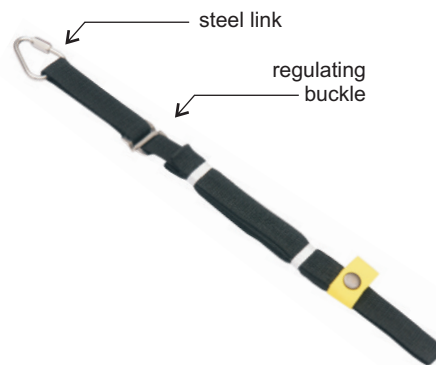

Tool boxes

AX-310

Toolbox 16"

Ref. AX 310

Dimensions: 410 x 210 mm x 190 mm
colour: black

AX-311

Toolbox 20"

Ref. AX 311

Dimensions: 510 x 260 mm x 230 mm
colour: black

AX-312

Toolbox 26"

Ref. AX 312

Dimensions: 580 x 290 mm x 280 mm
colour: black



AX-321

Case basic

Ref. AX 321

Dimensions: 310 x 410 mm x 120 mm
colour: grey

AX-322

Case basic

Ref. AX 322

Dimensions: 310 x 410 mm x 180 mm
colour: grey

Benches

BA BENCH

- Ref.: BA 010 - high range of working (h) = 10 m
- Ref.: BA 020 - high range of working (h) = 20 m
- Ref.: BA 030 - high range of working (h) = 30 m
- Ref.: BA 040 - high range of working (h) = 40 m

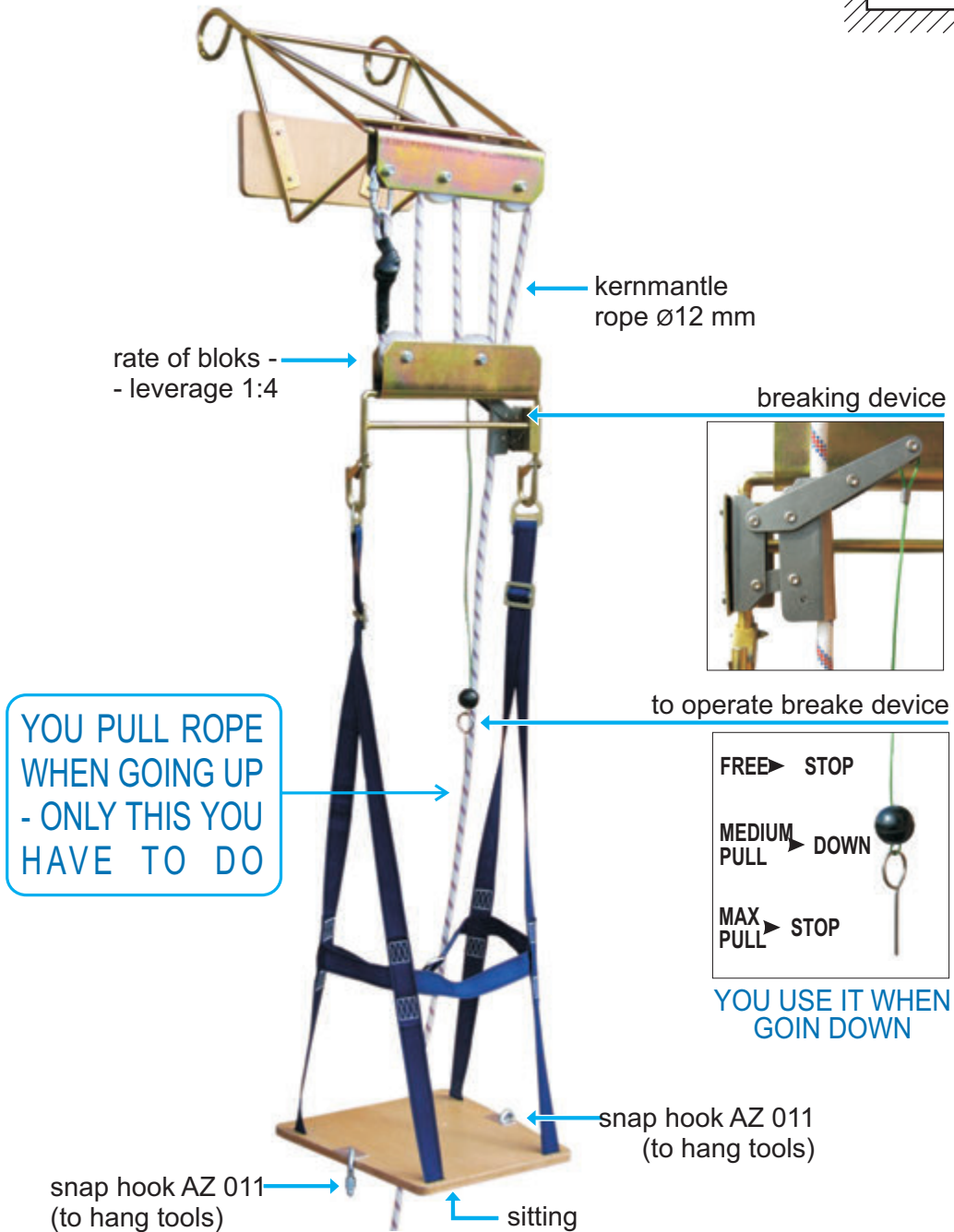
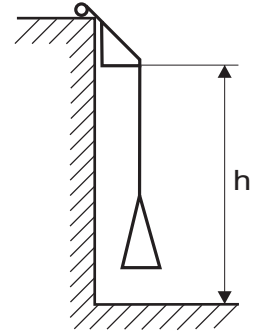

ATTENTION

YOU HAVE TO USE FALL PROTECTION WHEN SITTING !

BA 100 BENCH

Ref.: BA 100
Seat dimensions:
530 x 190 mm



BA 200 BENCH

Ref.: BA 200
Seat dimensions:
530 x 270 mm



BA 300 BENCH

Ref.: BA 300
Seat dimensions:
450 x 370 mm



Connectors

AZ 200

pipe anchor

EN 362



Ref.: AZ 200 01 - length 346 mm; clearance 81 mm

Ref.: AZ 200 02 - length 373 mm; clearance 112 mm

Ref.: AZ 200 03 - length 415 mm; clearance 140 mm



AZ 410

connecting lanyard

EN 354 EN 795



Ref.: AZ 410 - length 1m

- steel cable

- steel cable with AZ 011

Ref.: AZ 410 - length 2m

- steel cable

- steel cable with AZ 011



AZ 700

webbing sling

EN 795 klasa B



Ref.: AZ 700

Polyamide/polyester webbing 45 mm.

A syntetic rubber band is sewn on the webbing.

Static strength: 30kN

AZ 700 can be used to simultaneously protect the 3 persons with AE 320.



Ref.: AZ 700 - length 0,9 m

Ref.: AZ 700 - length 1,4 m

Ref.: AZ 700 - length 2,0 m

AZ 430

connecting lanyard

EN 795



Ref.: AZ 430

- steel cable with AZ 011

Ref.: AZ 430 - length 3 m

Ref.: AZ 430 - length 5 m

Ref.: AZ 430 - length 8 m

Ref.: AZ 430 - length 10 m



Connectors



AZ 900 webbing sling

EN 354 EN 795 klasa B



Ref.: AZ 900

Material: textile webbing

Width of tape: 20 mm

Static strength: 22kN

Ref.: AZ 900 030 - length 30 cm

Ref.: AZ 900 060 - length 60 cm

Ref.: AZ 900 080 - length 80 cm

Ref.: AZ 900 120 - length 120 cm

Ref.: AZ 900 150 - length 150 cm

Ref.: AZ 900 200 - length 200 cm

AZ 920 webbing sling

EN 354 EN 566



Ref.: AZ 920

Material: textile webbing

Width of tape: 20 mm

Static strength: 22kN

Ref.: AZ 920 015 - length 15 cm

Ref.: AZ 920 030 - length 30 cm

Ref.: AZ 920 060 - length 60 cm

Ref.: AZ 920 080 - length 80 cm

Ref.: AZ 920 120 - length 120 cm

Ref.: AZ 920 150 - length 150 cm

Ref.: AZ 920 200 - length 200 cm



Stretchers

DX 017 rescue stretcher

Ref.: DX 017
Steel profiles. Weight: 10kg

DX 018 alu rescue stretcher

Ref.: DX 018
Alu profiles. Weight: 4,9kg

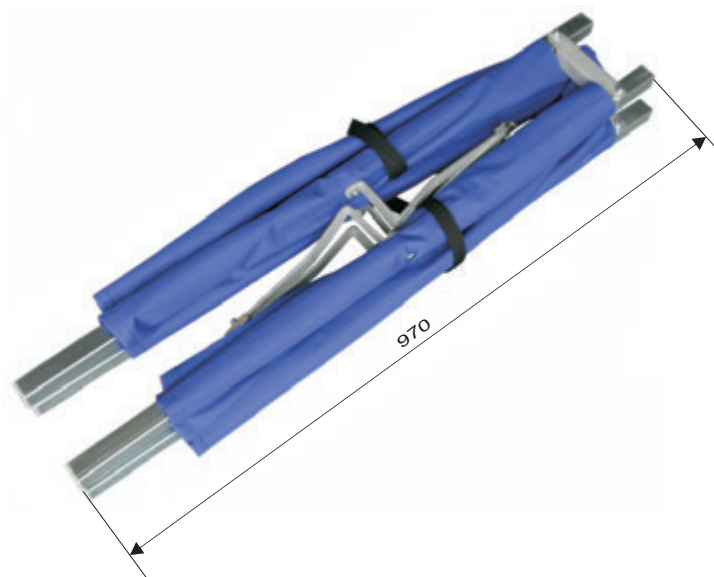
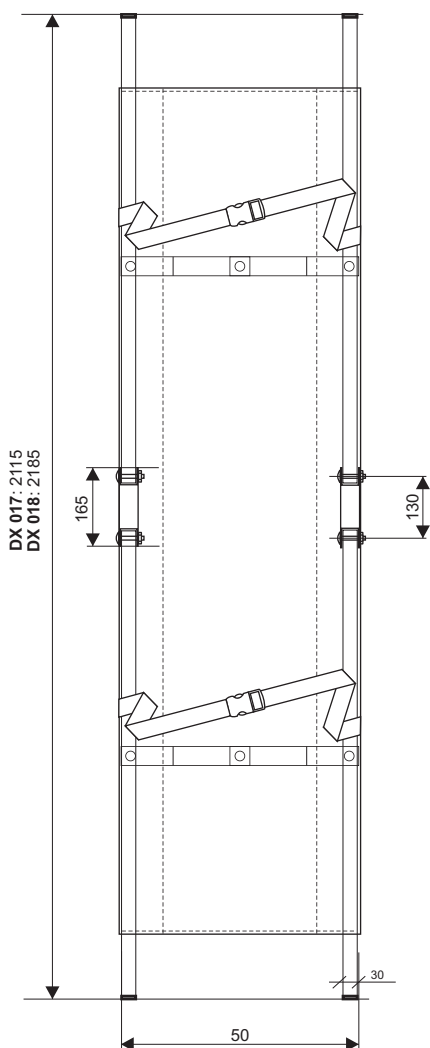
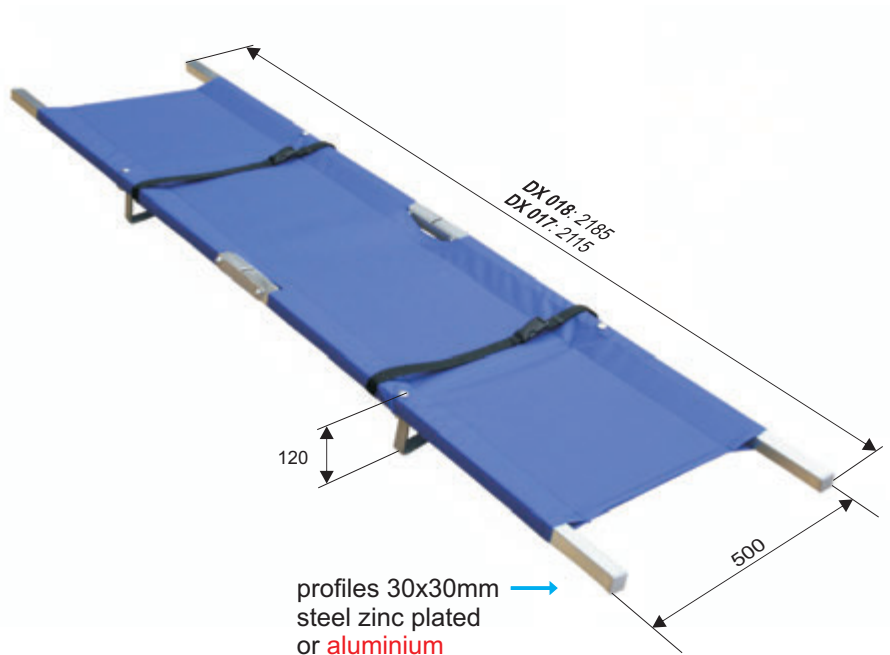

steel stretcher - 10 kg
alu stretcher - 4,9 kg

Stretchers

DX 020 set **NEW** rescue stretchers

Ref.: DX 020

Rescue stretchers DX 020 are specially designed for use in confined spaces with limited access. Their design enables usage in rescue operations at height, operations with helicopter, water rescue operations and military operations thanks to their versatility and ease of use.

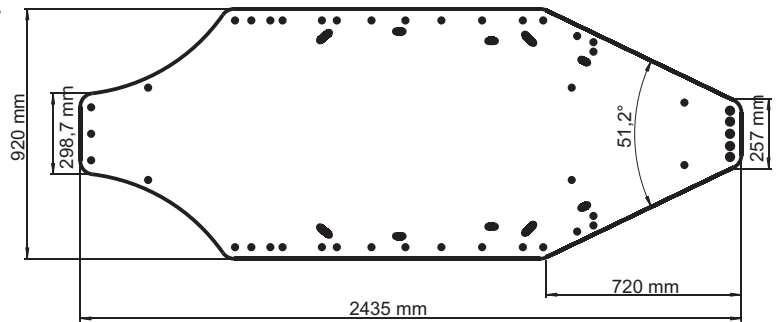

Parameters:

Size (unfolded): 2435x920mm

Size (folded): fi180x920mm

Weight: 6,26kg

Material: PCV + PS

Properties:

- antibacterial
- non-inflammable
- wear resistant
- flexible

Maximal load: 500kg



Sold as a set including:

- transport backpack with ear for pulling the stretchers with the casualty
- sling straps for horizontal transport
- fi10,5mm rope for vertical transport
- four additional holders for transport by a group of rescuers
- snap hooks AZ 018



Stretchers

DX 030 set **NEW** rescue stretchers

Ref.: DX 030

Rescue multifunctional stretchers

SLINGS



webbing
victim holders

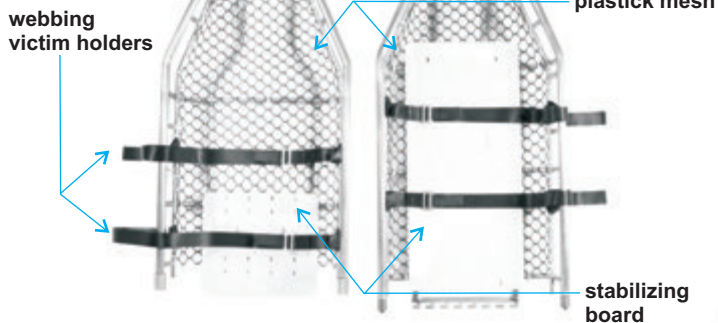

PARAMETERS:

- Basket material: stainless steel
- Stretcher can be take apart for easy transport
- Workong temperature: (+50)°C; (-50)°C; wet
- Static strength: not less 5,0 kN
- Braking Force: less than 10,0 kN
- Webbing victim holders
- Special plastic stabilizing board
- Plastic mesh
- Additional webbings (for helicopter or crane usage) - option
- Face protective shield - option

RANGES:

DX 030

Lmax = 2,125 m

weight with equipment: 16,0 kg

DIMENSIONS:

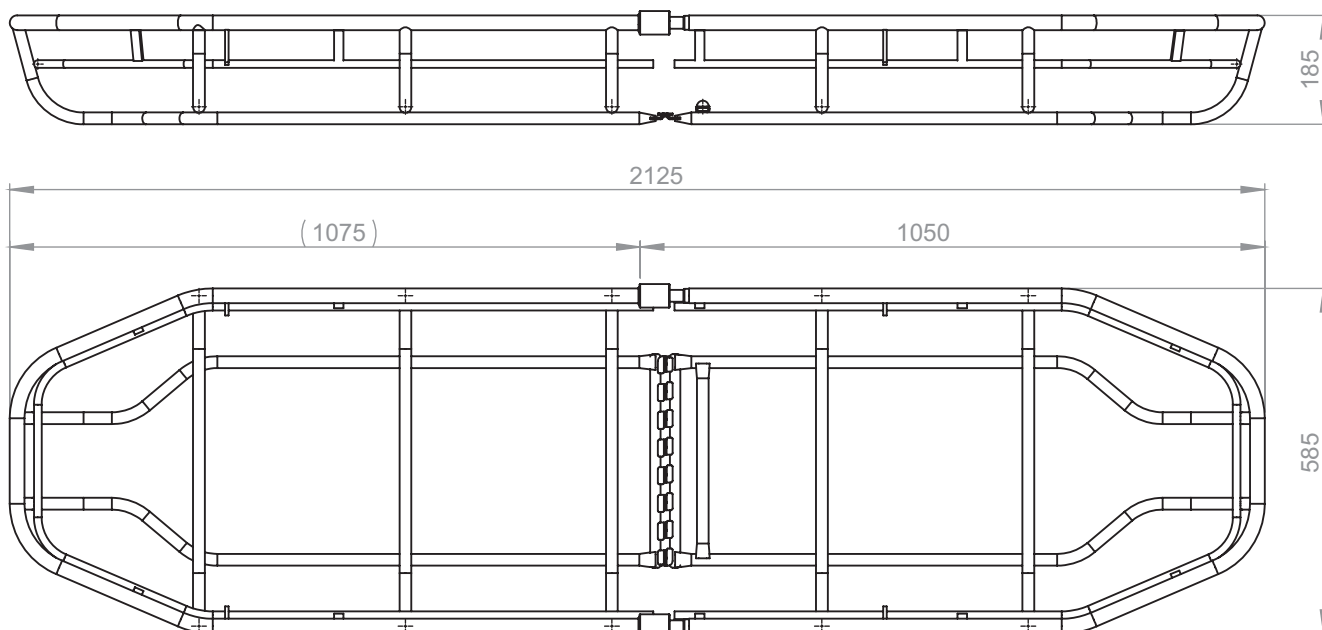

Kernmantle static rope

Poliester 100% termofixed

Ref.: LL 140 - Ø 14 mm

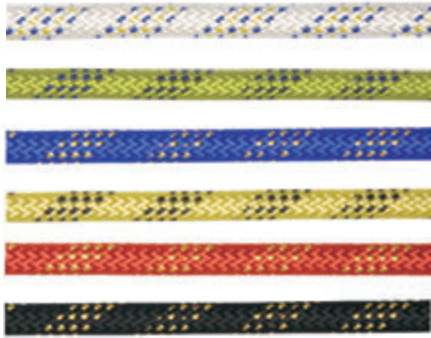

Ref.: LL 120 - Ø 12 mm

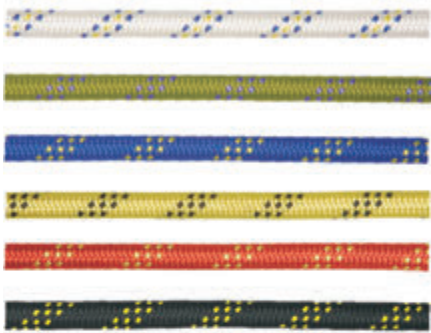

Ref.: LL 110 - Ø 10,5 mm

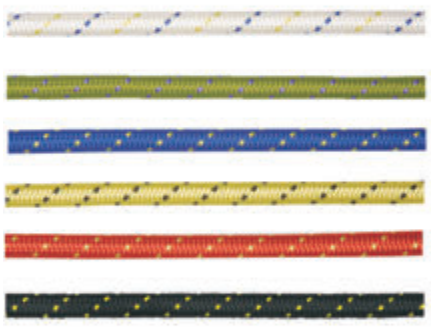

Quantity on bobbin:

- Ø 14,0mm - 125m
- Ø 12,0mm - 160m
- Ø 10,5mm - 200m
- Ø 8,0mm - 320m

Ref.: LL 080 - Ø 8 mm

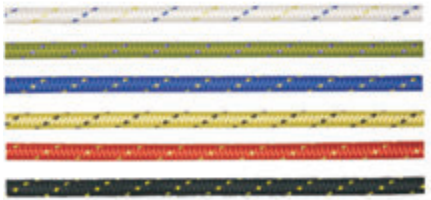

Ref.: LL 060 - Ø 6 mm

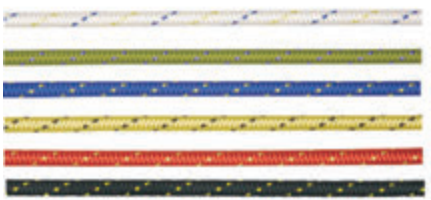

Baskets/Back Packs

Basket

TA 501 10

Dimensions: Ø240x280mm

Material: Cotton canvas colour: black, white **Ref. TA 501 10**

TA 501 20

Dimensions: Ø240x280 mm

Material: PVC colour: black, others **Ref. TA 501 20**

TA 501 30

Dimensions: Ø240x280 mm

Material: textile type cordura
colour: black, others

Ref. TA 501 30



Basket

TA 502 10

Dimensions: Ø300x400mm

Material: Cotton canvas colour: black, white **Ref. TA 502 10**

TA 502 20

Dimensions: Ø300x400mm

Material: PVC colour: black, others **Ref. TA 502 20**

TA 502 30

Dimensions: Ø300x400 mm

Material: textile type cordura
colour: black, others

Ref. TA 502 30

TA 601 BACK PACK

Ref.: TA 601

Dimensions: 400x290x140 mm



TA 701 BACK PACK

Ref.: TA 701

Dimensions: 500x350x200 mm



EXPERT BAG

Ref.: AX 013A

Dimensions: 600 x 450 x 450 mm

- adjustable padded shoulder strap
- additional adjustable strap for comfortable use
- overprint



plastic pocket inside for instruction manuals



Transport pack for climbing spikers

Ref.: AX 023

Dimensions: 470 x 320 x 160 mm

Material: reinforced PCV



Bags



AX-010

Transport bag

Dimensions: 380 x 450 mm Weight: 400 g
Material: PVC colour: blue, yellow, red

Ref. AX 010

AX-011

Transport bag

Dimensions: Ø 300 x 600 mm Weight: 600 g
Material: PVC colour: blue, yellow, red

Ref. AX 011

AX-012

Transport bag

Dimensions: Ø 400 x 800 mm Weight: 1050 g
Material: PVC colour: blue, yellow, red

Ref. AX 012



AX-09

Flat bag

Dimensions: 300 x 400 Weight: 120 g
Material: Cotton canvas
Colour: blue, yellow, red, green

Ref. AX 009



AX 011N

tool bag with handle

Dimensions: 300 x 300 x 600 mm
Material: PVC colour: blue, yellow, red

Ref. AX 011N



AX 008

Transport bag

Dimensions: 420 x 420 mm
Material: PCV colour: blue, yellow, red

Ref. AX 008



AX 011K

Transport bag with collar

Dimensions: 300 x 300 x 600 mm
Material: PCV colour: blue, yellow, red

Ref. AX 011K

Bags



AX-011D

Transport bag

Dimensions: Ø 300 x 300 x 600 mm

Material: PVC colour: blue, yellow, red

Ref. AX 011D



TA-301

Double pocketed tool bag for safety harness

Dimensions: 330 x 100 x 300 mm Weight: 360 g

Material: PVC colour: blue, yellow, red

Ref. TA 301



AX 801

Ballast bag

Max load: 5 kg

Material: PVC colour: blue, yellow, red

Ref. AX 801



AX-201

Metal case

Dimensions: 430 x 280 x 90 mm Weight: 2560 g

Material: painted steel

Ref. AX 201



AX-015

Tripod bag for TM-8

Dimensions: 1510 x 410 x 330 mm

Material: PVC colour: blue, yellow, red

Ref. AX 015

AX-202

Metal case

Dimensions: 430 x 280 x 120 mm Weight: 2860 g

Material: painted steel

Ref. AX 202

AX-016

Tripod bag for TM-9

Dimensions: 1800 x 230 x 200 mm

Material: PVC colour: blue, yellow, red

Ref. AX 016

AX-203

Metal case

Dimensions: 430 x 280 x 180 mm Weight: 3400 g

Material: painted steel

Ref. AX 203

Accessories

TU 320

rope protector

Ref. TU 320

Material: natural leather
Weight: 0,29 kg



TU 323

pad, rope protector

Ref. TU 323

Material: PS + PCV
Available colours: orange, and khaki

The pad is designed to serve as a multifunctional patch enabling i.e. comfort storing of laces and thin lines, protecting sharp edges when using lifelines, guarding rope ends against damaging by sheave blocks, etc.



TU 321

rope guard

Ref. TU 321

TU 321 - rope guard made of leather and PCV is suitable for rope of self-locking device and complies with EN 353-2 (Linostop II, AC 010), preventing the rope from wearing out.

Ref.: TU 321 050 - length 50 cm;

Ref.: TU 321 100 - length 100 cm;



TU 322

rope guard

Ref. TU 322

TU 322 - rope guard made of leather and PCV is suitable for rope of self-locking device and complies with EN 353-2 (Linostop II, AC 010), preventing the rope from wearing out.

Ref.: TU 322 050 - length 50 cm;

Ref.: TU 322 100 - length 100 cm;



Accessories



PS 001
Pad for safety harness

Ref. PS 001



AY 001
Tool holder

Ref. AY 001



AY 002
Tool holder

Ref. AY 002



AY 022
Tool holder with connecting buckle

Ref. AY 022



Accessories

AY-004 Periodic inspection TAG

option a)
last inspection

option b)
next inspection

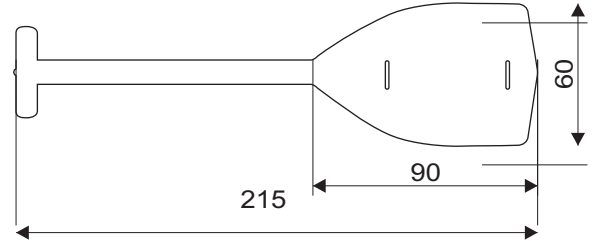
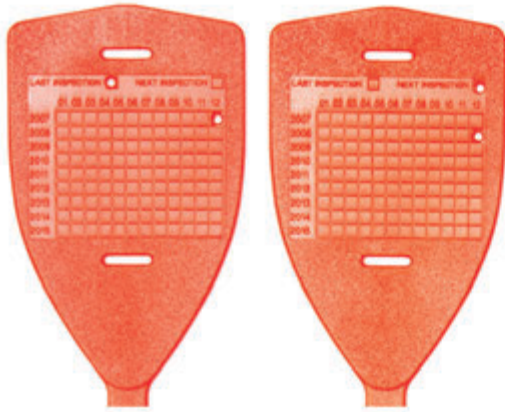

thickness 2,3 mm

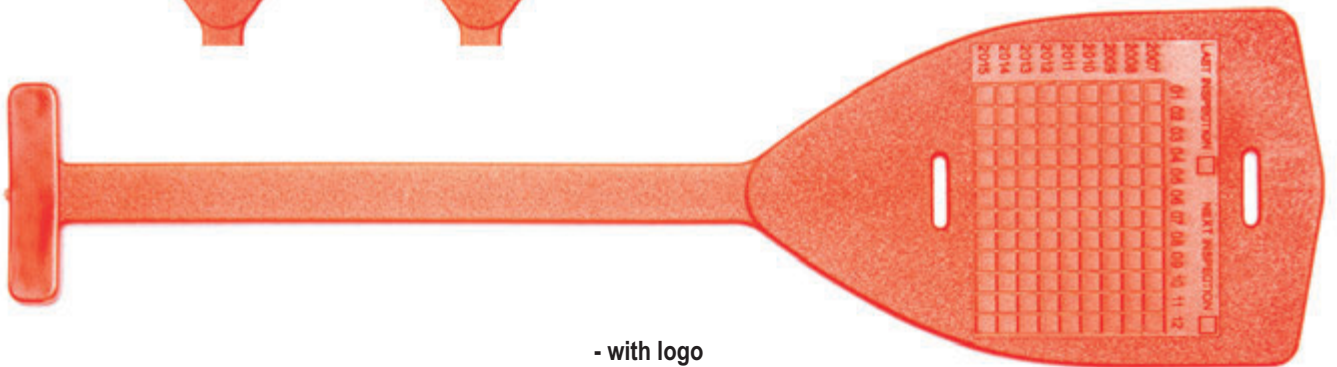

Example of usage



AY-005 Perforator

using perforator
mark a date
(month/year)
of the inspection



Accessories

AY 003 Retractable tool holder

Ref. AY 003

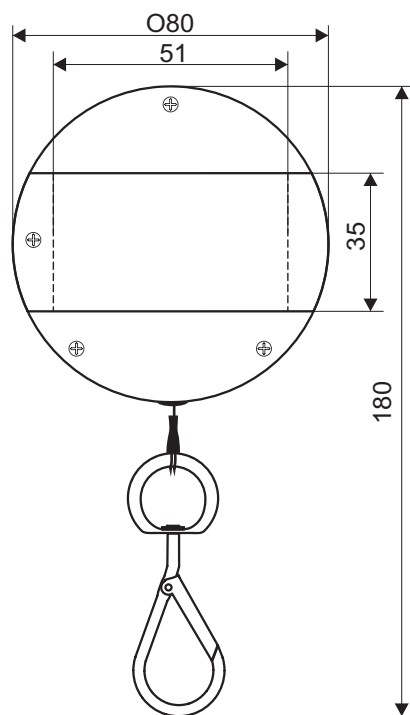
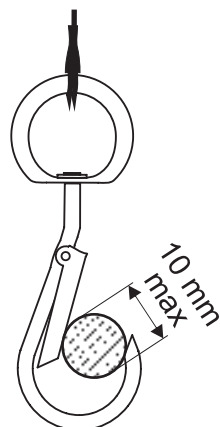

Example of usage

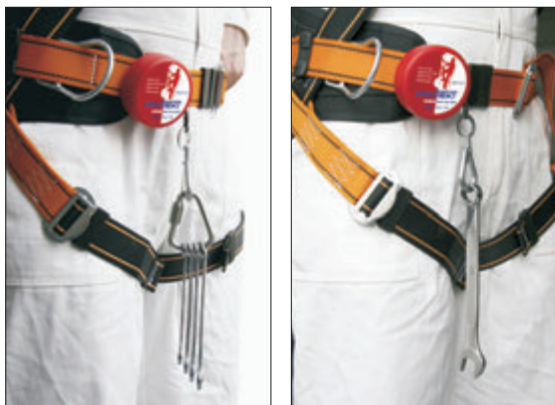

Use with Hand Tools Only

AY 023 Steel tool cable

Ref. AY 023



Harness display



DP-001 **Light harness display**

Light and handy trunk for harness exhibition.
Excellent for fair and presentation.

Elastic foam
and PCV composite

Color - Ash Grey

Thickness 53 mm

Weight 1,4 kg

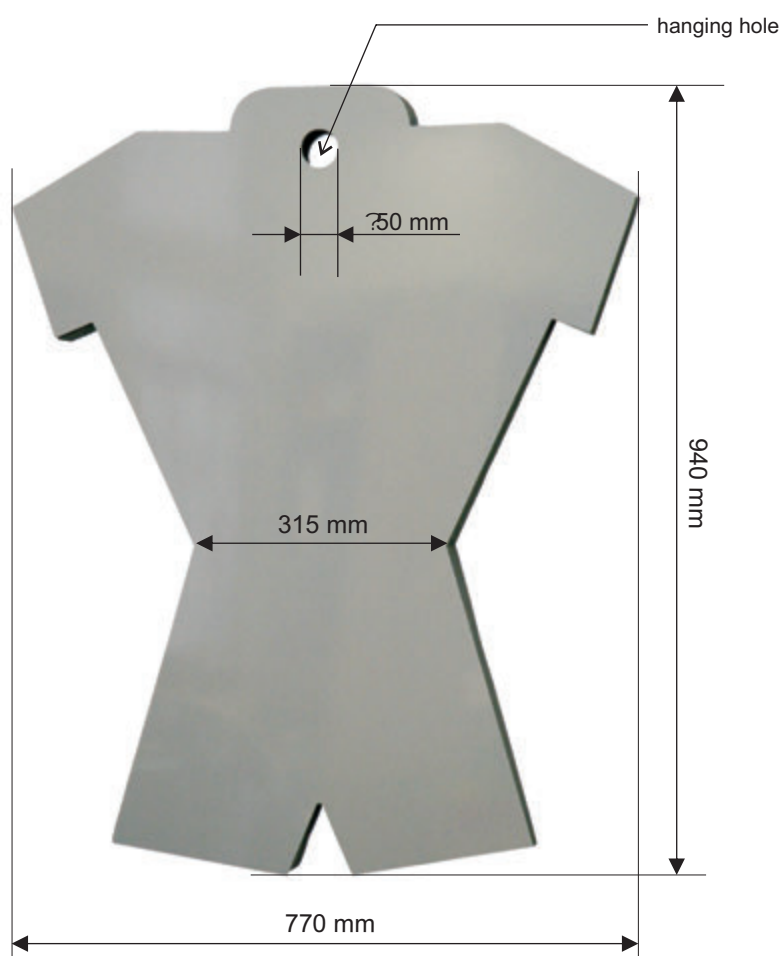

Elastic belt

PE 010
Elastic belt



XXL Ref.: PE 010 04

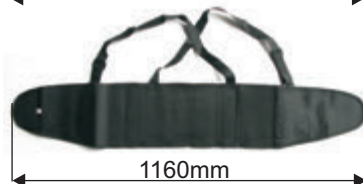

XL Ref.: PE 010 03



L Ref.: PE 010 02



M Ref.: PE 010 01

Screen

GT 020 SCREEN

NEW



Ref.: GT 020 160
Ref.: GT 020 161 + subtitles
Ref.: GT 020 180
Ref.: GT 020 181 + subtitles

Weight: 5,25kg - GT 020 160 (1,60m x 1,60m)
6,80kg - GT 020 180 (1,80m x 1,80m)

Material: polyester

Number of segments: 4

Dimensions of a single segment: 1,60 x 1,60m
1,80 x 1,80m

Version for police and fire brigade.



FAST AND EASY SET UP TAKE DOWN.

New stabilizing feet.

Material: powder coated steel

Dimensions: 60 x 8cm

Weight: 0,85kg



Stick with fiberglass.

Material: fiberglass

Length: 112,5cm

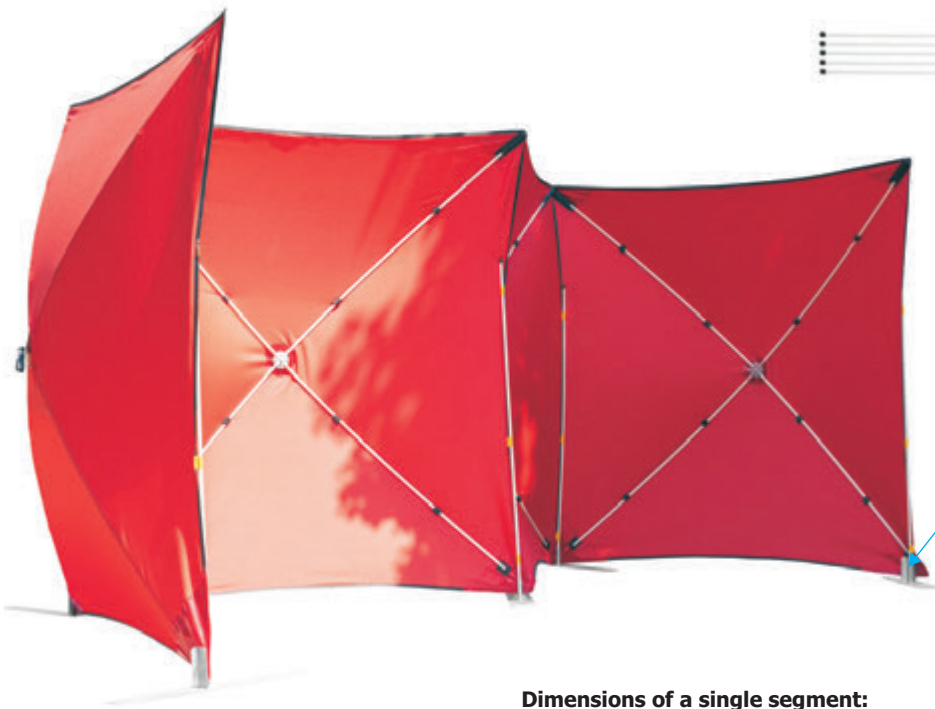

Stabilizing feet screen.



Primary colors:



Red



Blue

Dimensions of a single segment:

GT 020 160 - 120x20cm / GT 020 180 - 130x22cm



Dimensions of a single segment:

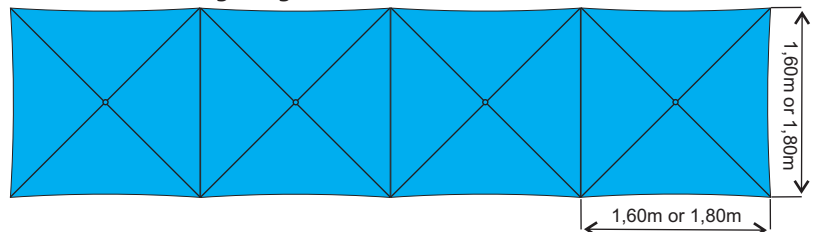

Screen

GT 030 **NEW**

SCREEN WITH REFLECTIVE STRIPS



Ref.: GT 030 160
Ref.: GT 030 161 + subtitles
Ref.: GT 030 180
Ref.: GT 030 181 + subtitles

Weight: 5,75kg - GT 030 160 (1,60m x 1,60m)
7,30kg - GT 030 180 (1,80m x 1,80m)

Material: polyester

Number of segments: 4

Dimensions of a single segment: 1,60 x 1,60m
1,80 x 1,80m



FAST AND EASY SET UP TAKE DOWN.

Version for police and fire brigade.



New stabilizing feet.

Material: powder coated steel
Dimensions: 60 x 8cm
Weight: 0,85kg



Stick with fiberglass.

Material: fiberglass
Length: 112,5cm



Stabilizing feet screen.



Primary colors:



Dimensions of a single segment:

GT 030 160 - 120x20cm / GT 030 180 - 130x22cm



Dimensions of a single segment:

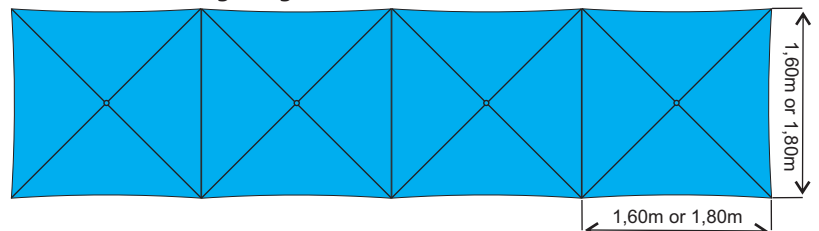

Ground tent

GT 110 Ground tent

Ref. GT 110

- Fast and easy set up and take down
- High visibility yellow and white colours
- Tie down capabilities to the inside or outside
- Screen window with flaps on two side

Weight: 10,00 kg

Dimensions: 180 x 180 x 180 cm

Folded size: 140 x 25 x 25 cm

Material: polyester

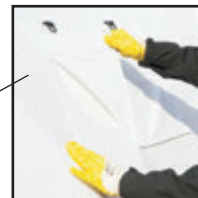
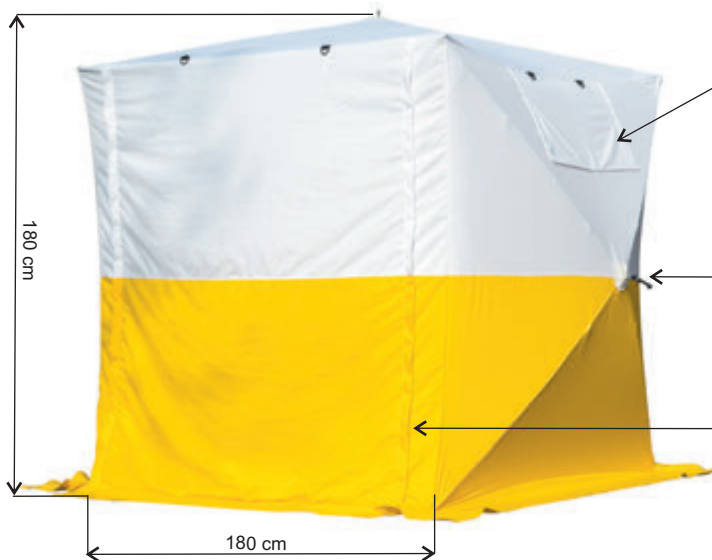
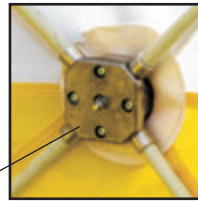

**Open set up time - 3 min.
Close set up time - 3 min.**

Plastic safety barrier

AT 210 **NEW**

PLASTIC SAFETY BARRIER



Ref.: AT 210

PARAMETERS

Number of spans: 4

Material: PCV

Weight: 7 kg

folded size: 102 x 72 x 11,5 cm

Dimensions: 272 x 102 cm

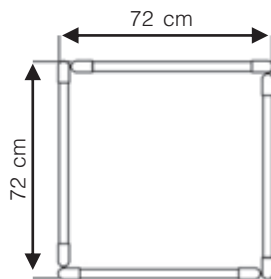
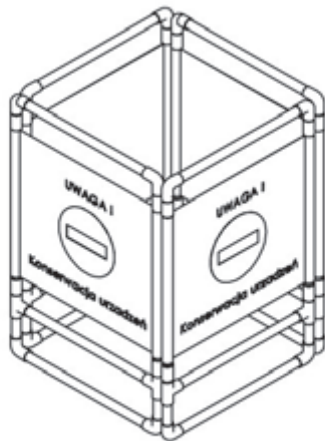

AT 210-02 **NEW**

CONNECTOR



Ref.: AT 210-02

PARAMETERS

Material: PCV

Weight: 200 g

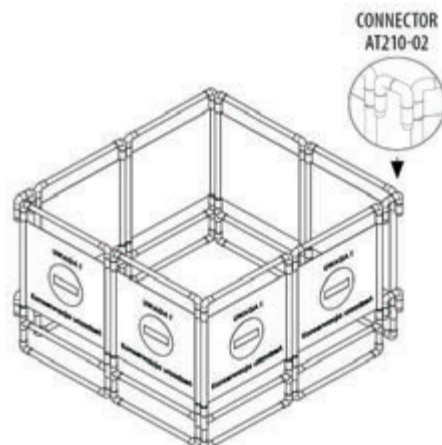

Blowers and accessories



WP 013 Plastic blower

Ref. WP 013

Motor specification

- Voltage: 230-250 V
- Frequency: 50-60 Hz
- Electric Motor: 745 W

Dimensions

- Weight: 14,75 kg
- Height: 53,30 cm
- Length: 43,15 cm
- Width: 35,55 cm

Noise - 85 dB

Airflow - 3552 m³/h



Duct

Ref. WP 110

Diameter: 20 cm - for WP-011

WP 110 04 - max. length 4,00 m

WP 110 07 - max. length 7,10 m

Ref. WP 130

Diameter: 29 cm - for WP-013

WP 130 04 - max. length 4,00 m

WP 130 07 - max. length 7,10 m



WP 011 Plastic blower

Ref. WP 011

Motor specification

- Voltage: 230-250 V
- Frequency: 50-60 Hz
- Electric Motor: 185 W

Dimensions

- Weight: 8,10 kg
- Height: 47,00 cm
- Length: 38,10 cm
- Width: 31,75 cm

Noise - 80 dB

Airflow - 1392 m³/h



Duct connector

Ref. WP 310

Diameter: 20 cm - for WP-011

Ref. WP 330

Diameter: 29 cm - for WP-013



Duct coupler

Ref. WP 410

Diameter: 20 cm - for WP-011

Ref. WP 430

Diameter: 29 cm - for WP-013



Blowers and accessories

WP 212

Complete ventilation set



WP 200

Duct with carrier

WP 200 04

- Max. duct length - 4,00 m
- Duct diam. 20 cm
- Weight - 5,30 kg
- Carrier height: 36 cm
- Carrier length: 58 cm
- Carrier width: 30 cm

WP 200 07

- Max. duct length - 7,10 m
- Duct diam. 25 cm
- Weight - 10,30 kg
- Carrier height: 36 cm
- Carrier length: 82 cm
- Carrier width: 30 cm



WP 212 04 (WP 012 + WP 200 04)

- Max. duct length - 4,00 m (duct diam. 20 cm)
- Weight - 13,30 kg
- Height: 36 cm
- Length: 80 cm
- Width: 30 cm
- Airflow - 1182 m³/h

WP 212 07 (WP 012 + WP 200 07)

- Max. duct length - 7,10 m (duct diam. 25 cm)
- Weight - 18,30 kg
- Height: 36 cm
- Length: 105 cm
- Width: 30 cm
- Airflow - 1130 m³ /h

Motor specification

- Voltage: 230-250 V
- Frequency: 50-60 Hz
- Electric Motor: 245 W

Ultra quiet - 74 dB

WP 012

Plastic blower

Ref. WP 012

Motor specification

- Voltage: 230-250 V
- Frequency: 50-60 Hz
- Electric Motor: 245 W

Dimensions

- Weight: 8,00 kg
- Height: 36 cm
- Length: 33 cm
- Width: 30 cm

Ultra quiet - 74 dB
Airflow - 1440 m³/h



Ladders

DL 010 **NEW**

WIDE ROPE LADDER

PN-83/W-52501-POINT 8



Ref. DL 010

DL 010 WIDE ROPE LADDER

Material:

steps - aluminium
rope - polyester 8 mm

Weight:

0,55 kg - 1 m.b.

Dimensions:

width - 310 mm
distance between steps - 310 mm

Length:

DL 010 05 - rope 5 m
DL 010 10 - rope 10 m
DL 010 15 - rope 15 m
DL 010 20 - rope 20 m
DL 010 25 - rope 25 m
DL 010 30 - rope 30 m



Ladders

DL 010C **NEW**

WIDE ROPE LADDER

PN-83/W-52501-POINT 8



Ref. DL 010C

DL 010C WIDE ROPE LADDER

Material:

steps - aluminium
rope - polyester 8 mm

Weight:

0,55 kg - 1 m.b.

Dimensions:

width - 310 mm
distance between steps - 310 mm

Length:

DL 010C 05 - rope 5 m
DL 010C 10 - rope 10 m
DL 010C 15 - rope 15 m
DL 010C 20 - rope 20 m
DL 010C 25 - rope 25 m
DL 010C 30 - rope 30 m



Ladders

DL 011 **NEW**

NARROW ROPE LADDER

PN-83/W-52501-POINT 8



Ref. DL 011

DL 011 NARROW ROPE LADDER

Material:

steps - aluminium
rope - galvanized steel 4 mm

Weight:

0,3 kg - 1 m.b.

Dimensions:

width - 210 mm
distance between steps - 310 mm

Length:

DL 011 05 - rope 5 m
DL 011 10 - rope 10 m
DL 011 15 - rope 15 m
DL 011 20 - rope 20 m
DL 011 25 - rope 25 m
DL 011 30 - rope 30 m

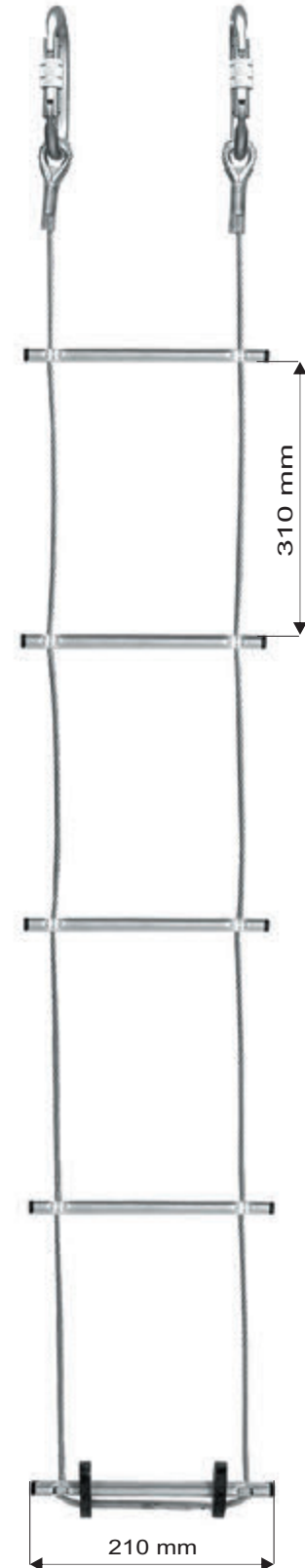

DL 012 **NEW**

WIDE ROPE LADDER

PN-83/W-52501-POINT 8



Ref. DL 012

DL 012 WIDE ROPE LADDER

Material:

steps - aluminium
rope - galvanized steel 4 mm

Weight:

0,58 kg - 1 m.b.

Dimensions:

width - 310 mm
distance between steps - 310 mm

Length:

DL 012 05 - rope 5 m
DL 012 10 - rope 10 m
DL 012 15 - rope 15 m
DL 012 20 - rope 20 m
DL 012 15 - rope 25 m
DL 012 30 - rope 30 m

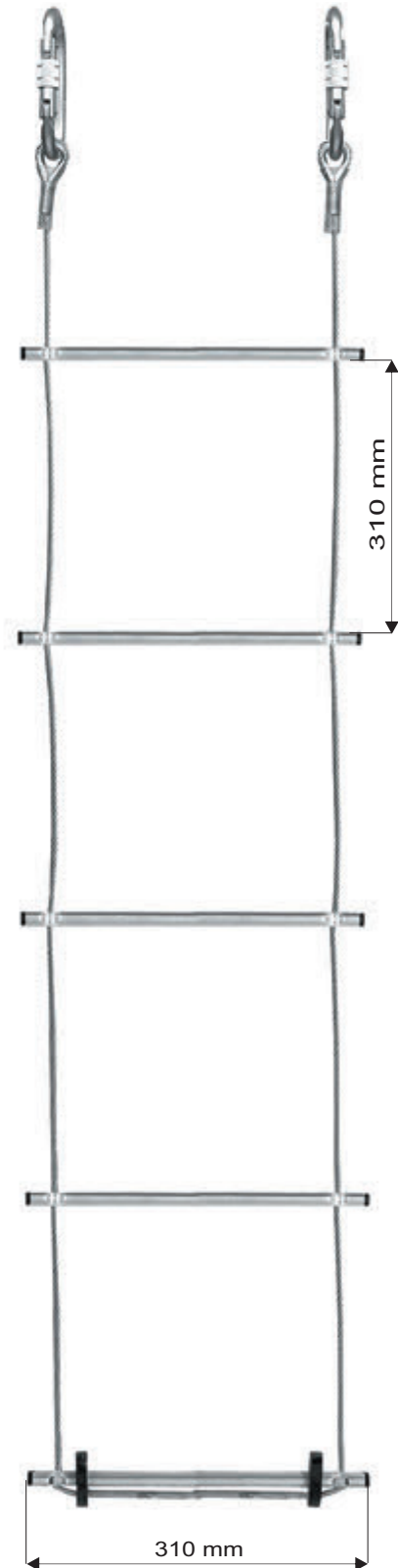

Ladders

DL 013 **NEW**

NARROW ROPE LADDER

PN-83/W-52501-POINT 8



Ref. DL 013

DL 013 NARROW ROPE LADDER

Material:

steps - aluminium
rope - polyester 8 mm

Weight:

0,35 kg - 1 m.b.

Dimensions:

width - 210 mm
distance between steps - 310 mm

Length:

DL 013 05 - rope 5 m
DL 013 10 - rope 10 m
DL 013 15 - rope 15 m
DL 013 20 - rope 20 m
DL 013 25 - rope 25 m
DL 013 30 - rope 30 m



Ladders

DL 013C **NEW**

NARROW ROPE LADDER

PN-83/W-52501-POINT 8



Ref. DL 013C

DL 013C NARROW ROPE LADDER

Material:

steps - aluminium
rope - polyester 8 mm

Weight:

0,3 kg - 1 m.b.

Dimensions:

width - 210 mm
distance between steps - 310 mm

Length:

DL 013C 05 - rope 5 m
DL 013C 10 - rope 10 m
DL 013C 15 - rope 15 m
DL 013C 20 - rope 20 m
DL 013C 25 - rope 25 m
DL 013C 30 - rope 30 m



DL 014, DL 015 ROOF LADDER **NEW**

PN-83/W-52501-POINT 8



Ref. DL 014, DL 015

DL 014 ROOF LADDER WITH STEEL ROPE

Material:

steps - aluminium
rope - galvanized steel 4 mm
mounting - galvanized steel
rubber - EPDM

Weight:

2,5 kg - 1 m.b.

Dimensions:

width - 310 mm
distance between steps - 310 mm

Length:

DL 014 03 - rope 3 m
DL 014 05 - rope 5 m

DL 015 ROOF LADDER WITH POLYESTER ROPE

Material:

steps - aluminium
rope - polyester 8 mm
mounting - galvanized steel
rubber - EPDM

Weight:

2,5 kg - 1 m.b.

Dimensions:

width - 310 mm
distance between steps - 310 mm

Length:

DL 015 03 - rope 3 m
DL 015 05 - rope 5 m

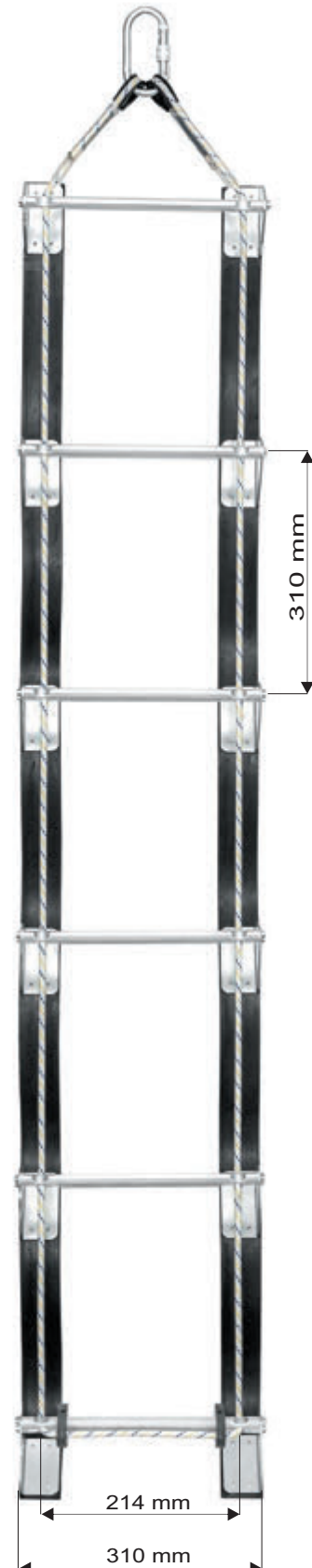
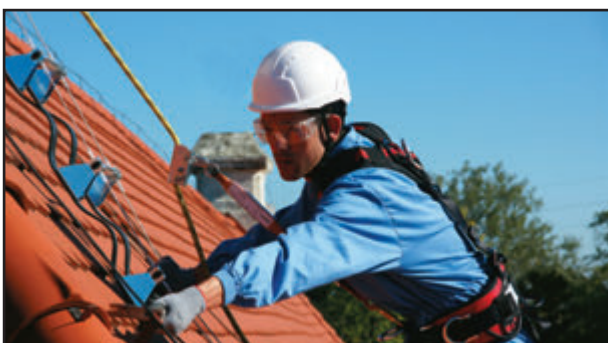

Protective helmets

CUPPIE 1 Industrial Bump Cap

EN 812

CE

Ref. HA 131



Colors available



CUPPIE 2 Industrial Bump Cap

EN 812

CE

Ref. HA 132



Colors available

orange
yellow green
red
green
combo blue
black
grey
blue
white



EVO-LITE Protective helmet

CE

Ref. HA 005

**THE LIGHTEST PROTECTIVE HELMET
AVAILABLE ON THE MARKET**

At only 300g, EvoLite is extremely light, i.e. approx. 20% less than standard helmets.

Low weight, combined with a very comfortable suspension strap and unique three-point adjustable depth of the suspension strap provides a perfect fit for any size of the head.

Thanks to its light shell, made from ABS, and the innovative structure, Evo Lite surpasses the requirements of EN397 standard.



Telescopic pole

DT 200, DT 201, DT 202 TELESCOPIC POLE

Ref.: DT 200, DT 201, DT 202

Pole can be used with:

- anchor hooks,
- rope installators
- acoustic sensors and other compatible with head UDI devices.

A device to instal the cable in hardly accessible locations. Individual parts of the rod are locjed in any position. It cooperates with hook for handing the cable, acoustic detectors and other devices which collaborate with the UDI head.

TECHNICAL DATAS DT 200:

Working reach: 8,88 m
Weight: 4,17 kg
Max. length: 7,38 m
Min. length: 1,96 m
Admissible load of the pole head: 5 kg
Voltage rating: 30 kV

TECHNICAL DATAS DT 201:

Working reach: 7,50 m
Weight: 2,70 kg
Max. length: 6,00 m
Min. length: 1,85 m
Admissible load of the pole head: 5 kg
Voltage rating: 30 kV

TECHNICAL DATAS DT 202:

Working reach: 5,78 m
Weight: 2,38 kg
Max. length: 4,28 m
Min. length: 1,80 m
Admissible load of the pole head: 5 kg
Voltage rating: 30 kV



hanging hook
Ref.: DT 600
mounting screw

Ref.: DT 202

Ref.: DT 201

Ref.: DT 200

head UDI
Ref.: DT 800



rope installer

Ref.: DT 720 01
Head UDI
Weight: 1,3 kg
Material: stainless steel + PCV
Rope diameter: \varnothing 6-10 mm



rope installer

Ref.: DT 720 02
Head UDI
Weight: 1,1 kg
Material: stainless steel
Rope diameter: \varnothing 6-10 mm



Bag for DT 200, DT 201, DT 202

Ref.: AXDT 200
Dimensions: 200 cm (length) x 7 cm (diameter)



extention section
Ref.: DT 900
head UDI

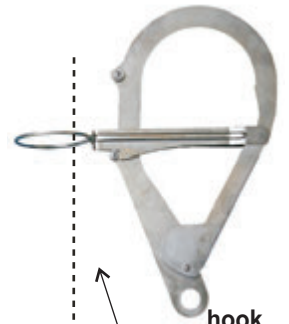

hook
Ref.: DT 651 02
Weight: 0,90 kg
Opening 90 mm

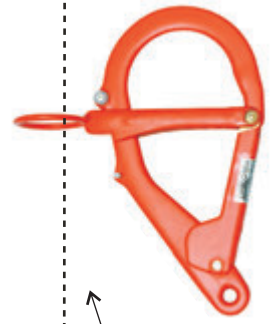

hook
Ref.: DT 651 01
Weight: 1,10 kg
Opening 90 mm

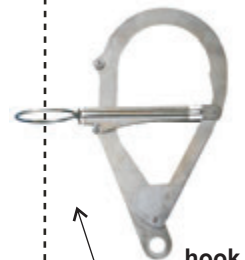

hook
Ref.: DT 650 02
Weight: 0,60 kg
Opening 75 mm

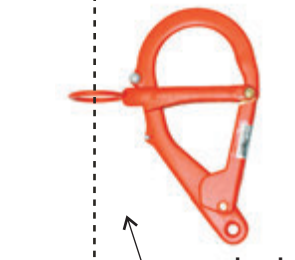

hook
Ref.: DT 650 01
Weight: 0,75 kg
Opening 75 mm



hanging hook
Ref.: DT 600
head UDI

Furniture and load movers

WT 101

Furniture and load
hydraulic mover **NEW**

Ref.: WT 101

Dimensions: 815 x 570 x 260 mm

Lifting capacity: 1600 kg = 16 kN

Lifting height: 200 mm

Weight: 20 kg

Hydraulic drive

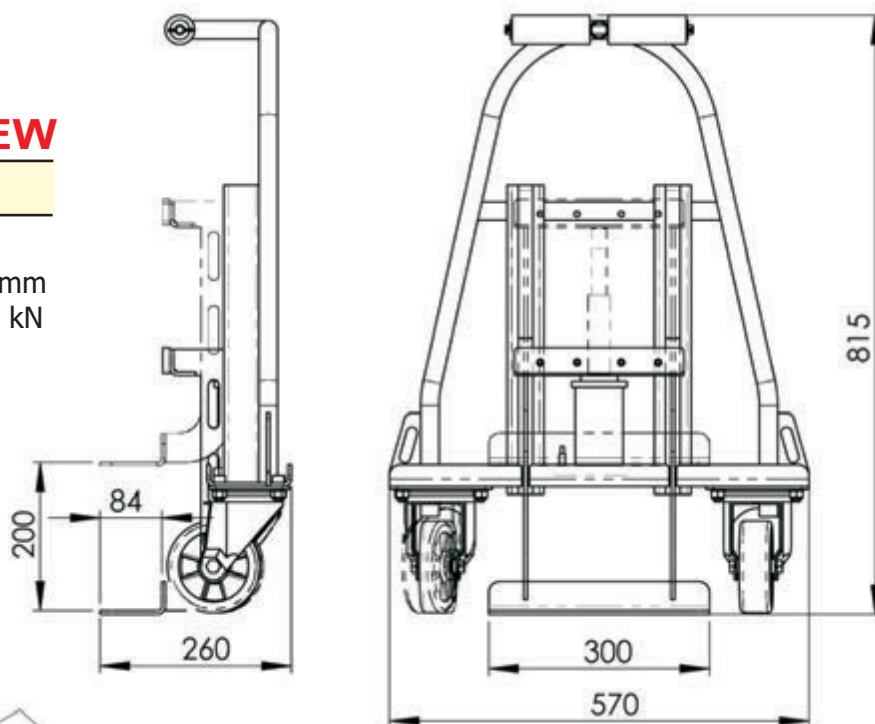

USE OF THE DEVICE

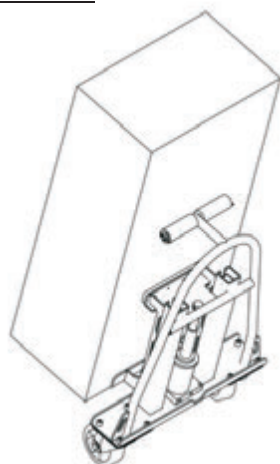

WT 101 + fastening tape

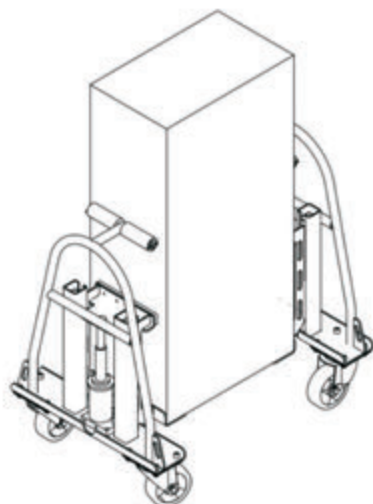

SET: 2 x WT 101 + fastening tape



Climbing irons

DR-1 STEEL CLIMBING IRONS



Ref.: SP 501

Weight: 3,75 kg
Material: steel, gaffs - hardened steel
Sold in pairs only.



DR-2A ALUMINIUM ALLOY ADJUSTABLE CLIMBING IRONS



Ref.: SP 502

Weight: 2,56 kg
Material: aluminium alloy, gaffs - hardened steel
Adjustable length
Sold in pairs only.



DR-4 STEEL CLIMBING IRONS



Ref.: SP 504

Weight: 4,00 kg
Material: steel, gaffs - hardened steel
Sold in pairs only.

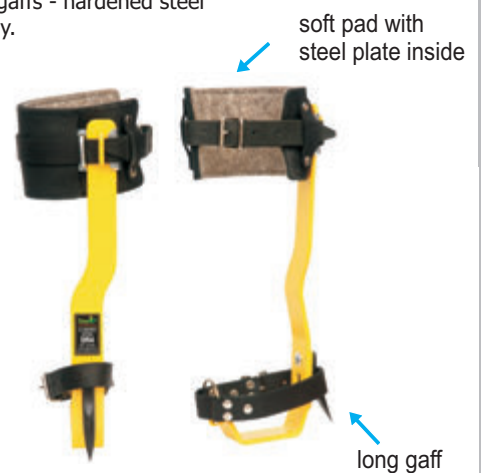

DR-3A ALUMINIUM ALLOY ADJUSTABLE CLIMBING IRONS



Ref.: SP 503

Weight: 2,70 kg
Material: aluminium alloy, gaffs - hardened steel
Adjustable length
Sold in pairs only.



Climbing irons

DR-2 STEEL CLIMBING IRONS



Ref.: SP 505

Weight: 3,80 kg
Material: steel, gaffs - hardened steel
Sold in pairs only.



SP 052, SP 054 LONG GAFF



Ref.: SP 052, SP 054

Material: hardened steel
Sold in pairs only.

SP 052 - DR-2A, DR-3A
SP 054 - DR-1, DR-4



DR-3 STEEL CLIMBING IRONS



Ref.: SP 506

Weight: 3,85 kg
Material: steel, gaffs - hardened steel
Sold in pairs only.



SP 051, SP 053 SHORT GAFF



Ref.: SP 052, SP 054

Material: hardened steel
Sold in pairs only.

SP 051 - DR-2A, DR-3A
SP 053 - DR-1, DR-4



Climbing irons

SP 101 CLIMBING IRONS

Ref.: SP 101

Weight: (pair)-3,0 kg

Material: steel, gaffs - hardened steel

For climbing and working on wooden masts and wooden poles with round cross section.

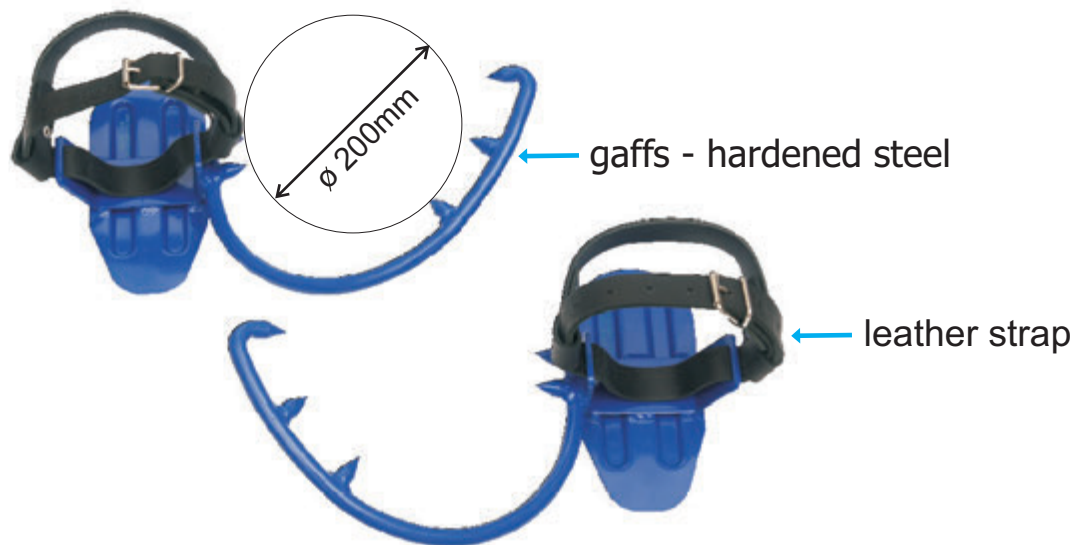

SP 102 CLIMBING IRONS

Ref.: SP 102

Weight: (pair)-3,2 kg

Material: steel, gaffs - hardened steel

For climbing and working on wooden masts and wooden poles with round cross section.

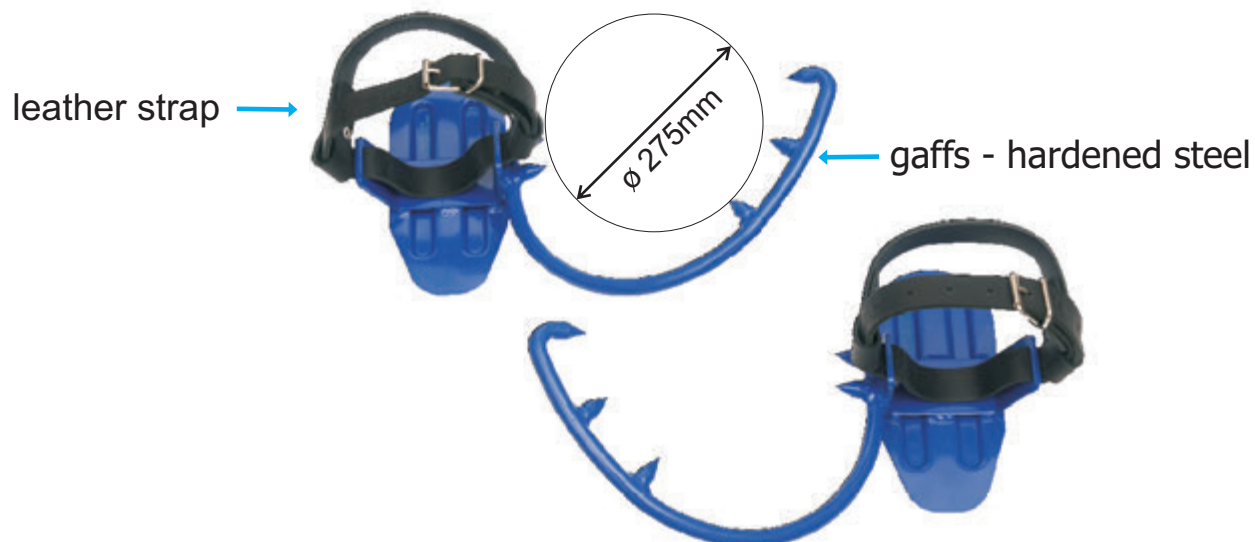

Climbing irons

SP 401 CLIMBING IRONS

Ref.: SP 401

Weight: (pair)-7,6 kg

Material: steel,

For climbing and working spin columns.



SP 402 CLIMBING IRONS

Ref.: SP 402

Weight: (pair)-8,0 kg

Material: steel,

For climbing and working spin columns.



Climbing irons

SP 203 / SP 204 / SP 205 CLIMBING IRONS

Ref.: SP 203, SP 204, SP 205

SP 203 - weight 5,0 kg - the reinforced concrete columns B10
SP 204 - weight 5,1 kg - the reinforced concrete columns B20
SP 205 - weight 5,2 kg - the reinforced concrete columns B40



SP 103 CLIMBING IRONS

Ref.: SP 103

Weight: (pair)-6,3 kg
Material: steel, gaffs - hardened steel
For climbing and working adjustable on wooden masts and wooden poles with round cross section.



∅ 130-300mm

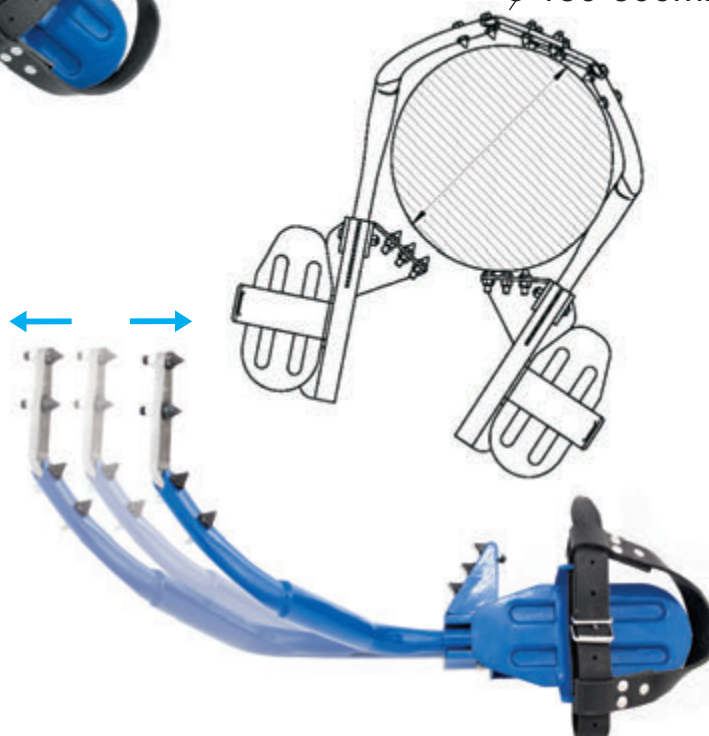
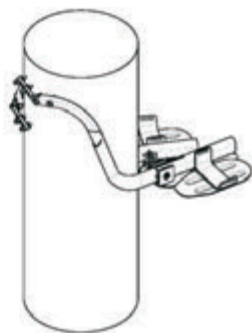
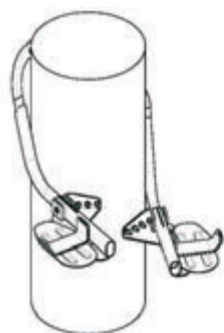

Arborist's trolleys

RS 221

Arborist's trolley

NEW!

Ref.: RS 221

Load capacity: 500 kg

It has been proven both in forest sites and in a homestead garden. It is an excellent solution for transporting materials in the back yard with difficult access. It accelerates transport ensuring high labour culture.

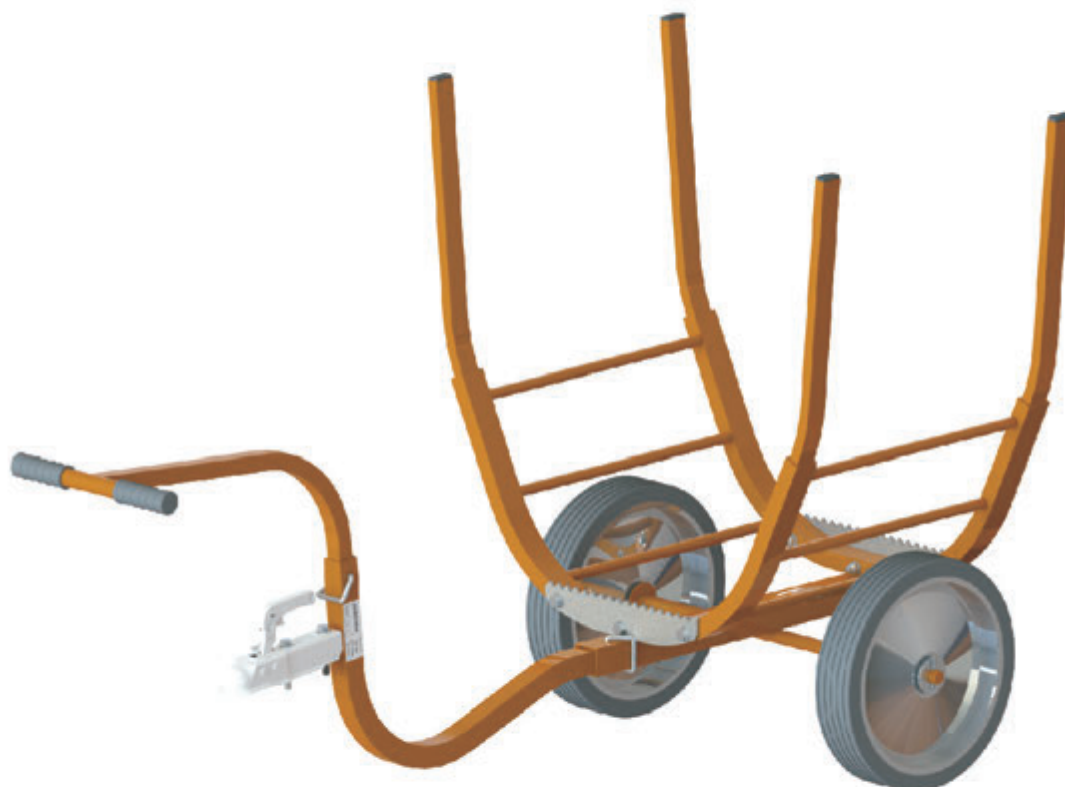
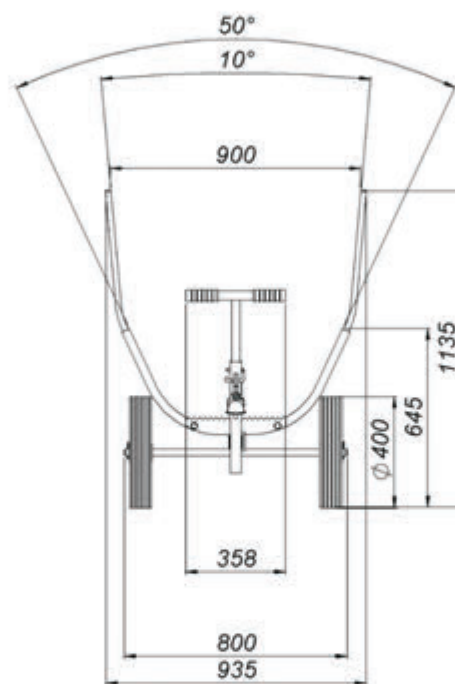
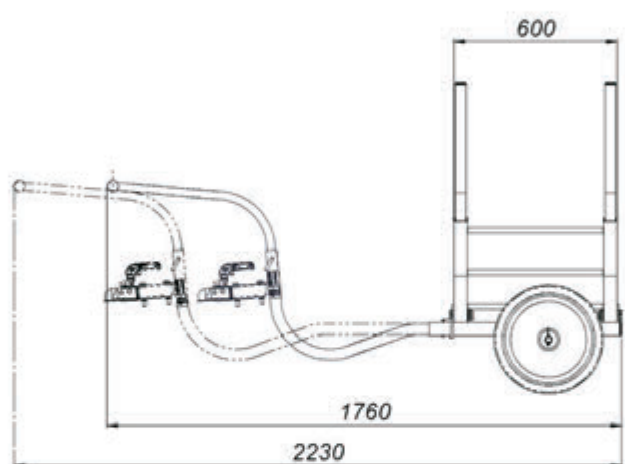

Arborist's trolleys

RS 220

Arborist's trolley

Ref.: RS 220

Load capacity: 500 kg
Lenght: beetwen 783 and 1683 mm
Height: 892 mm
Width: beetwen 855 and 1020 mm

The arborist's trolley is a multifunctional solution for timber transport. It has been proven both in forest sites and in a homestead garden. It is an excellent solution for transporting materials in the back yard with difficult access. It accelerates transport ensuring hogh labour culture.



Lashing straps

AX-500 RATCHET LASHING STRAP

EN 12195-2



Breaking Strength: LC 2500 daN
Webbing Width: 50 mm
Material: polyester
Static strength of tape: 7500 daN

AX 500 04 - length 4 m
AX 500 06 - length 6 m
AX 500 08 - length 8 m
AX 500 10 - length 10 m
AX 500 12 - length 12 m

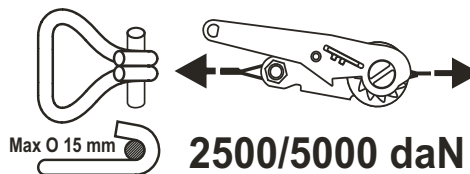
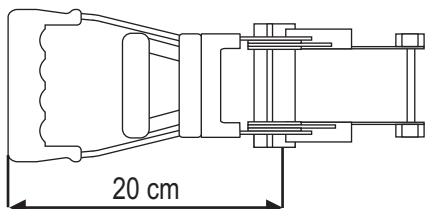

AX-501 RATCHET LASHING STRAP

EN 12195-2



Breaking Strength: LC 2500 daN
Webbing Width: 50 mm
Material: polyester
Static strength of tape: 7500 daN

AX 501 04 - length 4 m
AX 501 06 - length 6 m
AX 501 08 - length 8 m
AX 501 10 - length 10 m
AX 501 12 - length 12 m

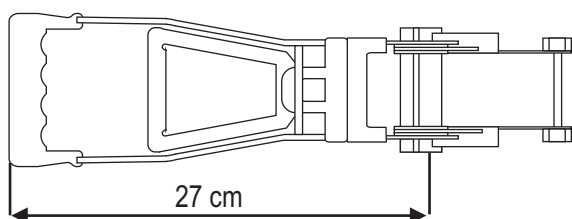

AX 501 04 - length 4 m
AX 501 06 - length 6 m
AX 501 08 - length 8 m
AX 501 10 - length 10 m
AX 501 12 - length 12 m

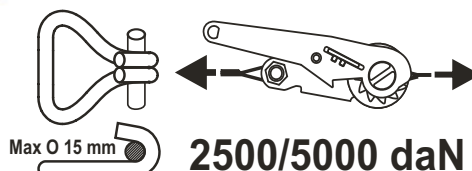
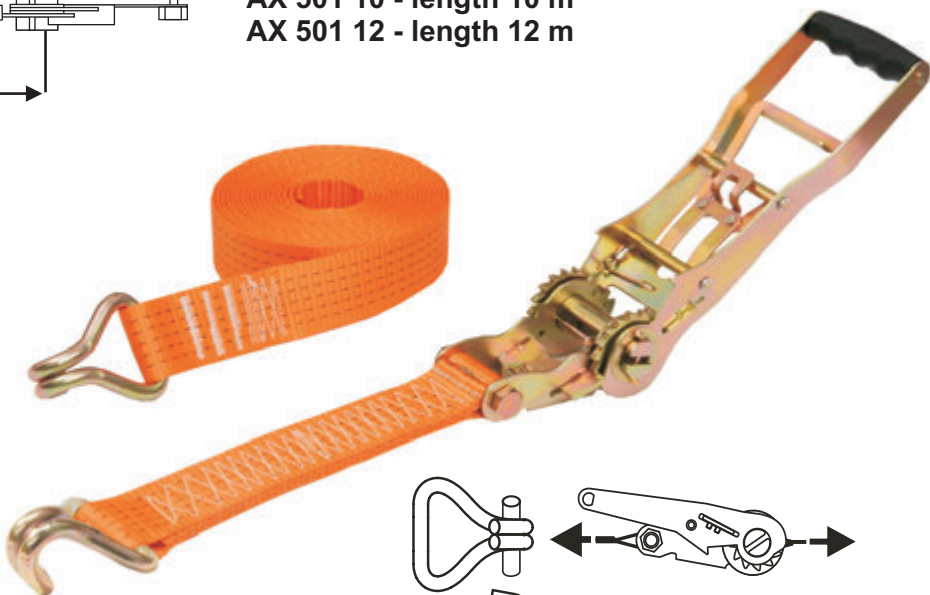

Telescopic ladders

DS 251

electroisolating telescopic ladder

Ref.: DS 251 05

Closed: 77 cm
Extended: 200 cm
Width: 50 cm
Weight: 5,50 kg

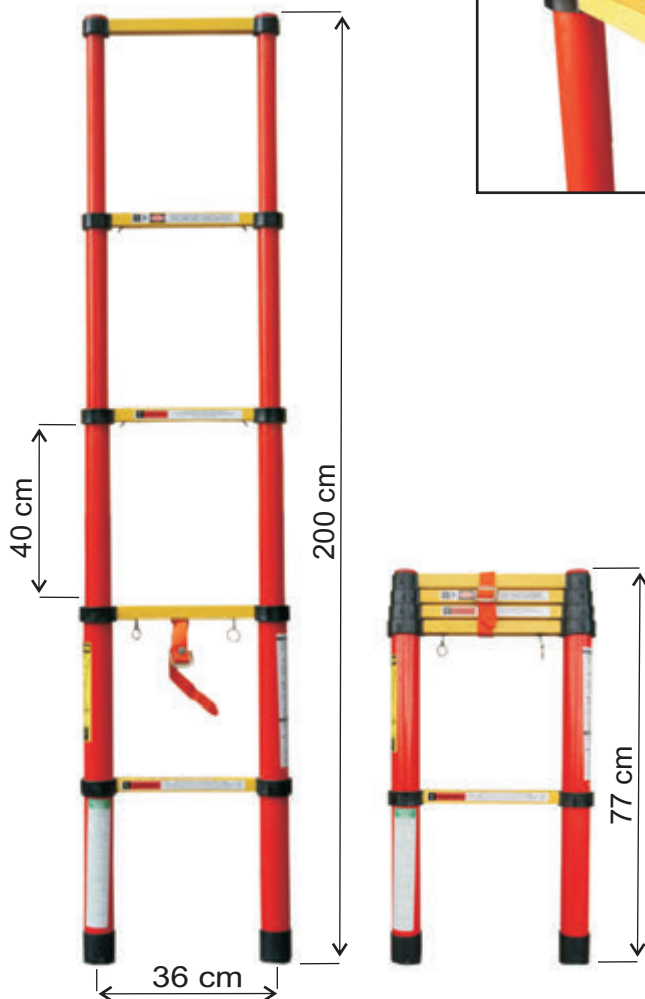

Ref.: DS 251 05

Ref.: DS 251 10

Closed: 90 cm
Extended: 380 cm
Width: 50 cm
Weight: 11,30 kg

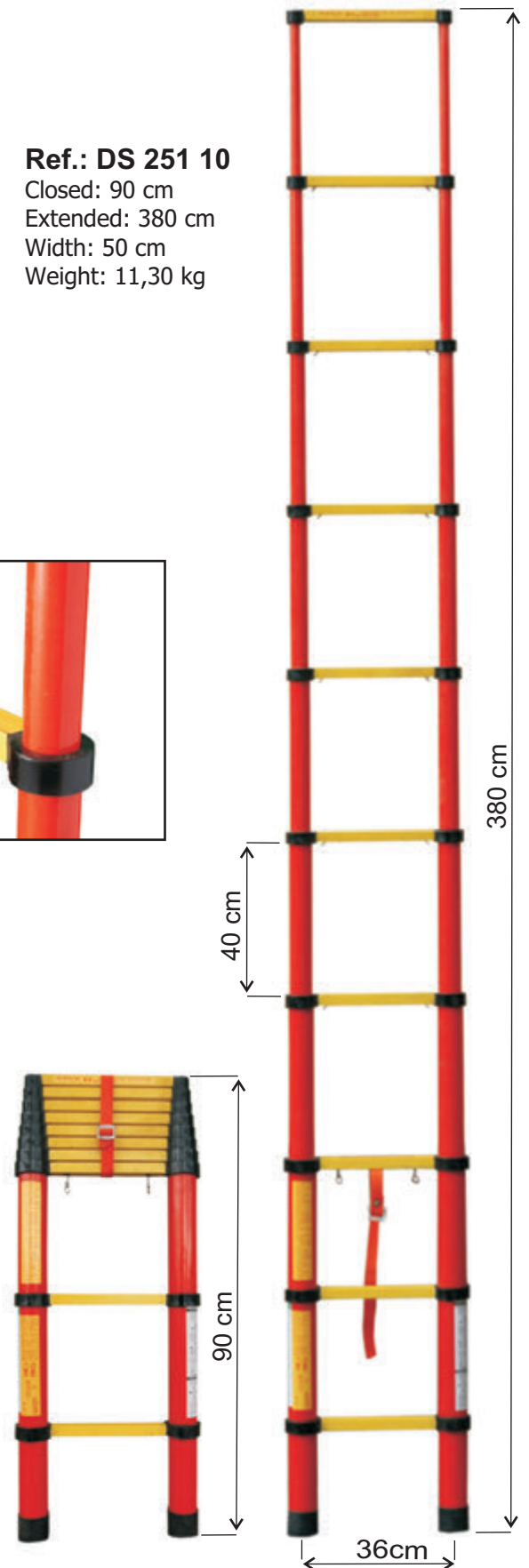

Ref.: DS 251 10

Telescopic ladders

DS 221 telescopic ladder

Ref.: DS 221 09

Closed: 88 cm
Extended: 280 cm
Width: 49 cm
Weight: 8 kg

Ref.: DS 221 13

Closed: 102 cm
Extended: 380 cm
Width: 49 cm
Weight: 13 kg

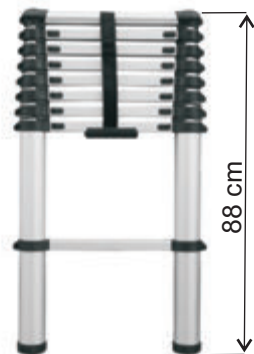
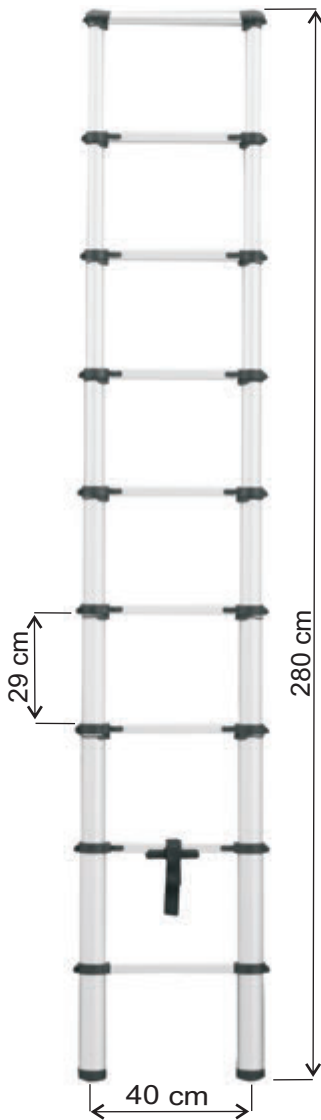

Ref.: DS 221 09



Ref.: DS 221 13



Telescopic ladders

DS 231 telescopic ladder

Ref.: DS 231 09

Closed: 79 cm

Extended: 285 cm

Width: 72 cm

Weight: 16 kg

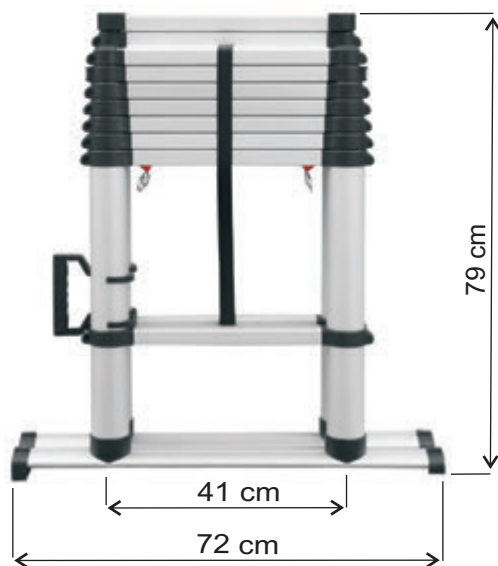

Platforms

RS 300

Mobile tank platform



Ref.: RS 300

Mobile tank platform for safe working at height.

Dimensions:

- working height: 2920-4400 mm
- dimensions security railing:
2100 mm x 1120 mm x 1720 mm
- dimensions of the base platform:

rear track: 845 mm;

front track: 2650 mm;

width rungs: 600 mm;



Stabilizing platform mechanism



Ladder positioner



Top-lower mechanism

Nonskid rungs



Pulleys

BP 200

Brake pulley

Ref.: BP 200 - 20m rope, device weight: 3,3 kg

Ref.: BP 200 - 30m rope, device weight: 5,0 kg

Ref.: BP 200 - 50m rope, device weight: 8,3 kg

Dimensions: 300 x 300 x 54mm

Max working load: 100kg

Material: galvanized steel, poliamid

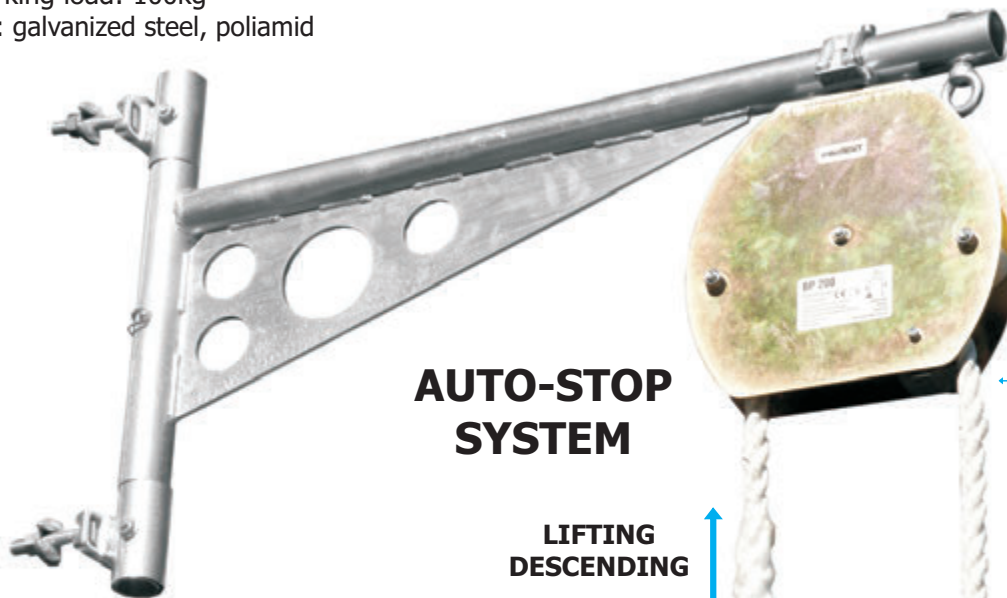

AUTO-STOP SYSTEM

AUTO-STOP
brake protection
against falling the load

LIFTING
DESCENDING

3-str. twisted
polyester rope
ø18 mm

S320C
(norm: DIN 689)
hook with latch
galvanized steel + paint
opening: 26 mm
weight: 410 g
Working load: 1000 kg
Breaking load: 5000 kg



instance applicable



BP 210

Arm to the scaffolding

Ref.: BP 210

Material: zinc plated steel



Pulleys

BP 020

Brake pulley

Ref.: BP 020 - 20m rope

Ref.: BP 030 - 30m rope

Ref.: BP 050 - 50m rope

Dimensions: 190 x 55 x 150mm

Max working load: 100kg

Device weight : 2,2kg

Material: steel, alu

instance applicable



AUTO-STOP SYSTEM

3-str. twisted polyester rope
ø14 mm

S320C
(norm: DIN 689)
hook with latch
galvanized steel + paint
opening: 26 mm
weight: 410 g
Working load: 1000 kg
Breaking load: 5000 kg



Anchor devices

Anchor device

EN 795 class B



Ref.: HL 709 01 - aluminium version

Device weight : 14 kg
Material: aluminium

Ref.: HL 709 02 - steel version

Device weight : 28 kg
Material: hot deep galvanized steel

Anchor post
HL 709



AE 320

safety horizontal webbing

Ref.: AE 320 10 with AZ 060 - max. 10 m
Ref.: AE 320 20 with AZ 060 - max. 20 m

Sewed bag for AE 320 - sewed to connecting webbing



Adapter mounting
HL 710

AX 019

Transport bag
for HL 709



Pulleys

TU 400

Pulley with a "twist-lock"

NEW!

EN 795:2012 Class B, EN 12278:2007

Dimensions: 176 x 96 x 88 mm

Weight: 1,38 kg

MBS: 100 kN

WLL: 20 kN

Safety factor: 1:5

Max cable diameter: <18 mm - never use with steel cables or chains.

Sling strength: max. 30 kg



available colors

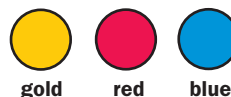

gold

red

blue

TU 401

Bolted pulle

NEW!

EN 795:2012 Class B, EN 12278:2007

Dimensions: 176 x 96 x 81 mm

Weight: 1,38 kg

MBS: 100 kN

WLL: 20 kN

Safety factor: 1:5

Max cable diameter: <18 mm - never use with steel cables or chains.

Sling strength: max. 30 kg



available colors



gold

red

blue

TU 413

Pulley block

NEW!

Machinery Directive: 2006/42/EEC;

Ref.: TU413

TECHNICAL DATA

Admissible working rope diameter: 12 mm

Gear ratio of the device: 3:1

WLL (Working Load Limit): 10 kN

MBS (Minimum Breaking Force): 50 kN

SF (Safety Factor): 5:1

Weight of set (without working rope): 2,47 kg

DESCRIPTION

TU 413 pulley block may be used in arboriculture (sectional tree felling) and lifting loads. Device is designed for lifting and lowering loads. The device is not designed for use as personal fall arresting equipment.

DESIGN

The **TU 413** pulley block set consist of the following elements:

- upper rope block with two wheels
- lower rope block with one wheel
- connector for catching end of the working rope with lower block (sold separately)
- working rope (sold separately)

Both (upper and lower) blocks consist of reinforced with fiberglass plastic wheels with ball bearings, connected with galvanized steel plates. The axles and connectors (bolts, nuts, washers) are made of galvanized steel. Each block is provided with swivel eye made of aluminium alloy. Upper block eye may be additionally rotated relative to the block body.

DESIGN

Ref. number of working rope TU 413 - 300 - L were:

L - working rope length (m.)

The length of working rope required to wind around all wheels of the device is 2.1 m..is automatically added to the ordered working length of the rope.

CONNECTOR FOR THE ROPE

Strength of rope connector must be at least 20 kN.
For example: Az011

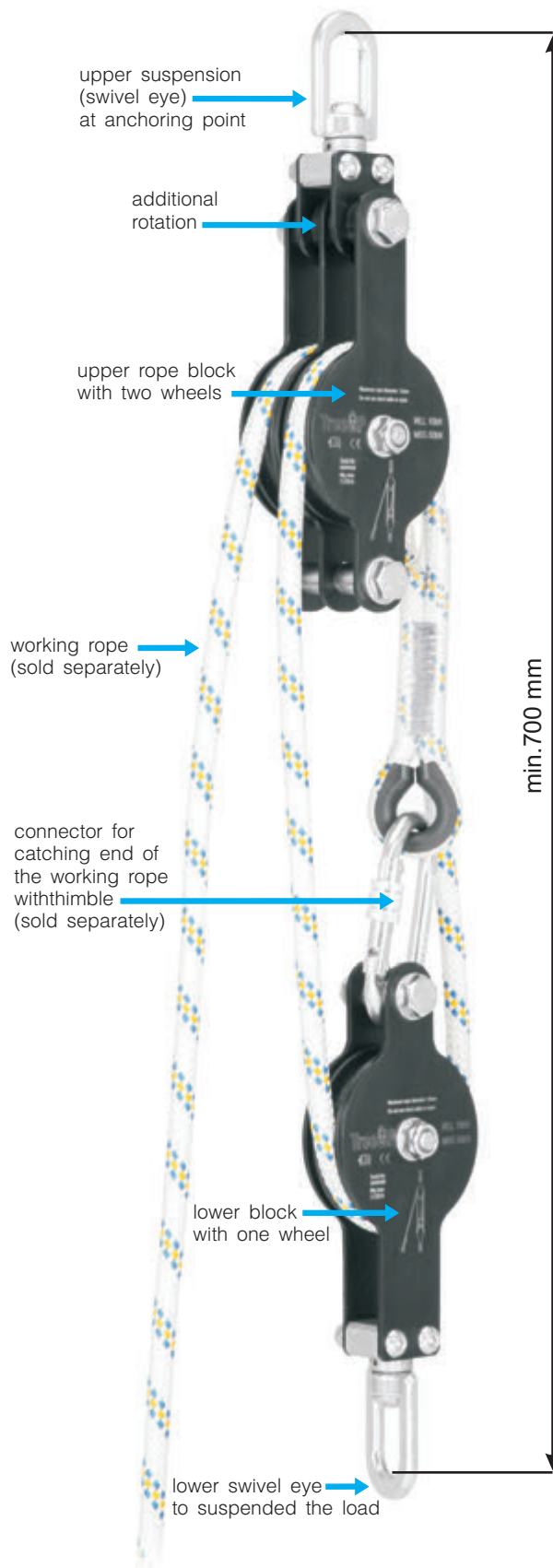

- Ref.: TU 413 - blocks without a rope
- Ref.: TU 413 10 - blocks with rope L=10 m
- Ref.: TU 413 20 - blocks with rope L=20 m
- Ref.: TU 413 30 - blocks with rope L=30 m
- Ref.: TU 413 40 - blocks with rope L=40 m
- Ref.: TU 413 50 - blocks with rope L=50 m

Pulleys

TU 410 - set

Pulley block

NEW!

Dimensions: 250 x 198 mm - TU 411

Dimensions: 198 x 198 mm - TU 412

Weight: 1822 g - TU 411

Weight: 1508 g - TU 412

Gear ratio (of the set): 4:1

Breaking force - MBS: 50 kN

Max. working load - WLL: 10 kN

Rope diameter: 8-12 mm (textile rope only)

Ref.: TU 410

Ref.: TU 411

Ref.: TU 412

The TU 410 pulley block is design to lift the material and loads.

It will be mainly used in sectional tree felling. It is used for controlled lowering of the material. By correct weaving the rope through the device, branches or parts (sections) of the trunk can be safely lowered. It is an ideal set for use in hardly accessible, confined spaces in the crowns of trees.

Special remark:

Since the gear ratio is 4:1 the ropes ordered should have 4x the length that would normally be ordered for the given use. For instance, there are 15 m of operating rope length in a 60 m long rope.

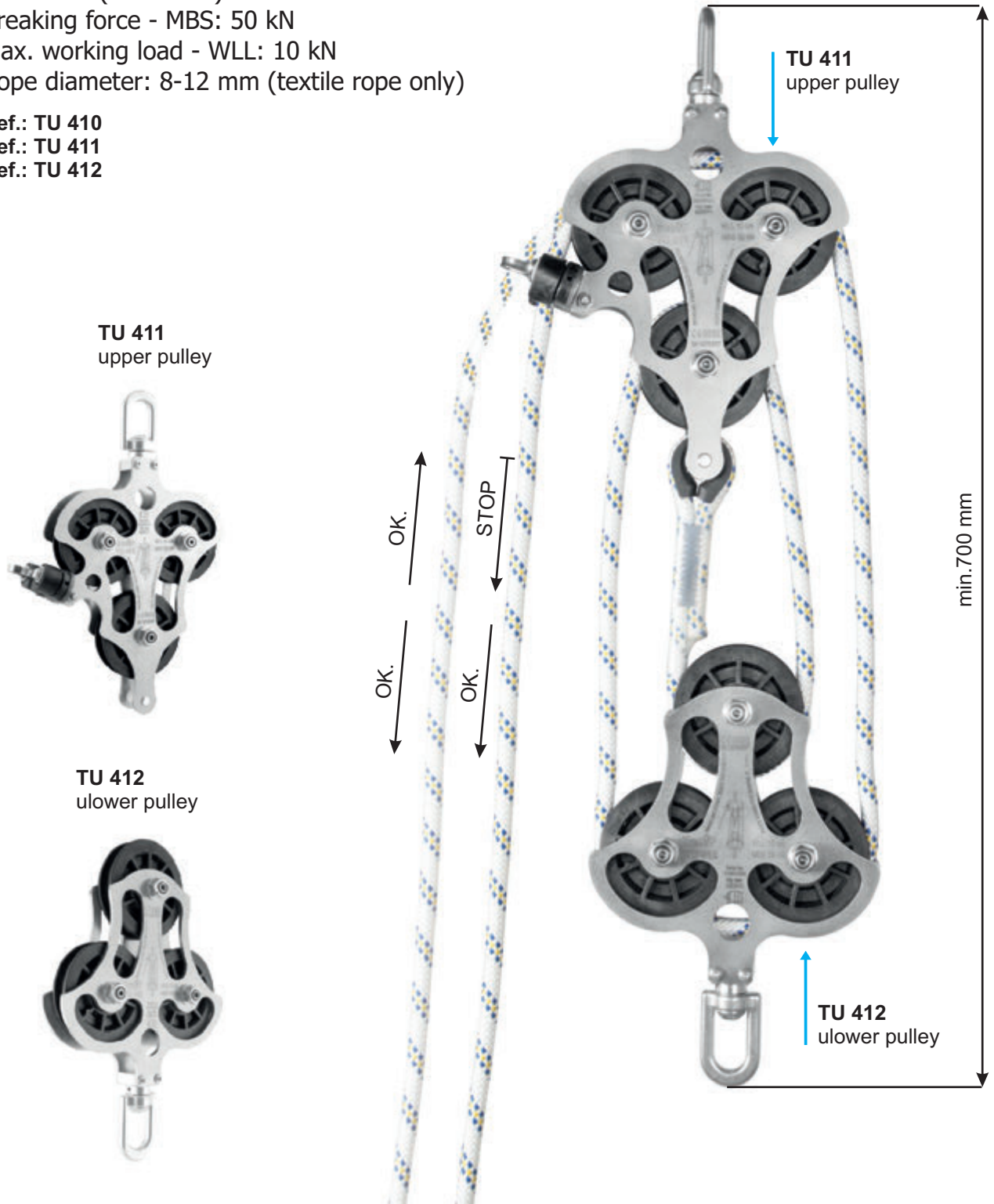

Pulleys

TU 440

Arborist pulley

NEW!

Ref.: TU440

PARAMETERS

Dimensions: 85 x 40 x 39 mm

MBS: 25 kN

WLL: 25 kN

Capacity: 500 kg (5 kN)

Weight: 153 g

Max. diameter of rope: \varnothing 10 mm

Max. width of tape: 21 mm

Material: aluminium, hardened steel

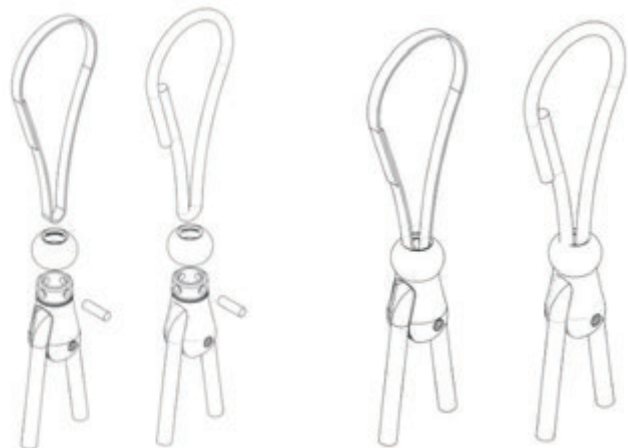

CONFIGURATIONS AVAILABLE

TU 701

Ref.: TU 701 080 - length L=80 cm

Ref.: TU 701 085 - length L=85 cm

Ref.: TU 701 090 - length L=90 cm

Ref.: TU 701 010 - length L=100 cm



TU 810

Ref.: TU 701 080 - length L=80 cm

Ref.: TU 701 085 - length L=85 cm

Ref.: TU 701 090 - length L=90 cm

Ref.: TU 701 010 - length L=100 cm



TU 811

Ref.: TU 811 080 - length L=80 cm

Ref.: TU 811 085 - length L=85 cm

Ref.: TU 811 090 - length L=90 cm

Ref.: TU 811 010 - length L=100 cm



AZ 900

Ref.: AZ 900 060 - length L=60 cm

Ref.: AZ 900 080 - length L=80 cm

Ref.: AZ 900 120 - length L=120 cm

Ref.: AZ 900 150 - length L=150 cm



CD 201, CD 202

Handled ascender

EN 567

Handled ascender:
right and left handed versions
Width: 134mm x 90mm x 28mm
Weight: 220g
Diameter rope: 8-13mm

Ref.: CD 201



Ref.: CD 202



CD 211, CD 212

Handled ascender

EN 567

Handled ascender:
right and left handed versions
Width: 207mm x 100mm x 28mm
Weight: 280g
Diameter rope: 8-13mm

- * Designed for ascending and occasionally for hauling (progress capture)
- * Wide, ergonomic molded handle allows a comfortable yet powerful grip
- * Toothed cam with self-cleaning slot optimizes performance under any conditions (e.g. frozen or dirty ropes)
- * Upper hole through which a carabiner attaches the device to the rope (useful for back-up belays or hauling)

Ref.: CD 211



Ref.: CD 212



Pulleys / Descenders

CD 101

Transport pulley

EN 12278

Ref.: CD 101

Double pulley for Tyrolean traverses on rope.

Width: 103mm x 90mm x 33mm

Weight: 250g

For use with ropes of maximum diameter 13mm

- * Aluminum sheaves mounted on self-lubricating bushings for efficiency
- * Accepts up to three carabiners to facilitate use



CD 302

Standard descenders

Ref.: CD 302

Figure 8 descender

Width: 108mm x 80mm x 7mm

Weight: 80g

- * Square shape to reduce twisting of the ropes and formation of a lark's head knot
- * Compact and lightweight



CD 201 ultra light, CD 202 ultra light

Handled ascender

EN 567

Handled ascender:
right and left handed versions
Width: 112mm x 95mm x 23mm
Weight: **135g**
Diameter rope: 8-13mm

NEW!

Ref.: CD 201L



Ref.: CD 202L



CD 211 ultra light, CD 212 ultra light

Handled ascender

EN 567

Handled ascender:
right and left handed versions
Width: 190mm x 93mm x 24mm
Weight: **205g**
Diameter rope: 8-13mm

NEW!

- * Designed for ascending and occasionally for hauling (progress capture)
- * Wide, ergonomic molded handle allows a comfortable yet powerful grip
- * Toothed cam with self-cleaning slot optimizes performance under any conditions (e.g. frozen or dirty ropes)
- * Upper hole through which a carabiner attaches the device to the rope (useful for back-up belays or hauling)

Ref.: CD 211L



Ref.: CD 212L



Blocks

TU 420

Arborist mini block

NEW!

Ref.: TU420

Maximum rope diameter: **<13,5 mm**

Do not use with wire ropes and chains.

Dimensions: 80 x 44 x 33 mm

Weight: 105 g

Material: aluminium

Breaking force - MBS: 25kN

Max. working load - WLL: 5kN

Factor of safety: 1:5

Axial fixing hole diameter: $\varnothing \geq 16$ mm

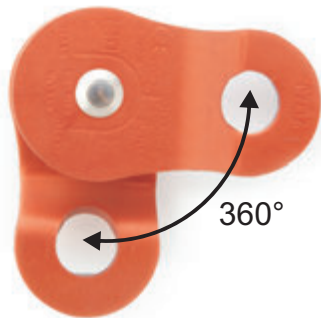

COLOURS: blue, sand, yellow, black, orange

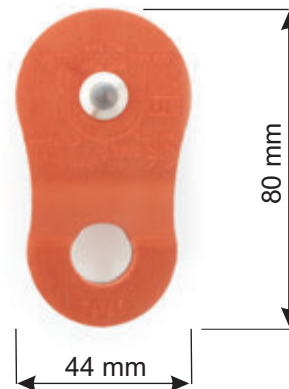

COLOURS: blue, sand, yellow, black, orange

TU 421

Triple arborist block

NEW!

Ref.: TU421

Maximum rope diameter: **<13,5 mm**

Do not use with wire ropes and chains.

Dimensions: 99 x 78 x 33 mm

Weight: 160 g

Material: aluminium

Breaking force - MBS: 25kN

Max. working load - WLL: 5kN

Factor of safety: 1:5

Axial fixing hole diameter: $\varnothing > 16$ mm

